



UDK  
62:502/504

ISSN 1849-4714 (Tisak)  
ISSN 1849-5079 (Online)

INŽENJERSTVO OKOLIŠA



ENVIRONMENTAL  
ENGINEERING

Scientific and professional journal in the area  
of environmental engineering

ISSUE TOPIC  
ENVIRONMENTAL HAZARDS

GEOTEHNIČKI  
FAKULTET,  
SVEUČILIŠTE U  
ZAGREBU

VARAŽDIN  
HRVATSKA

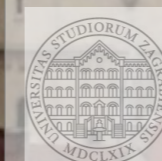

FACULTY OF  
GEOTECHNICAL  
ENGINEERING,  
UNIVERSITY OF  
ZAGREB

VARAŽDIN  
CROATIA

VOLUME 7  
NUMBER 1  
JULY 2020

# ENVIRONMENTAL ENGINEERING - INŽENJERSTVO OKOLIŠA



## Scientific and professional journal in the area of environmental engineering

The Journal publishes scientific and technical papers and other articles in the interdisciplinary area of environmental engineering. The scientific topics covered by the Journal include geo-engineering, water resources management, technical aspects of environmental protection and similar areas. Contributions include original scientific papers, preliminary communications, short notes, review papers or technical papers.

**Short journal name:** EnvEng-IO

**Journal is published biannually.**

**All papers published in journal have been peer-reviewed.**

**The full text of all articles is available for free at the journal web site and Hrčak:**

<https://www.gfv.unizg.hr/static/casopis-inzenjerstvo-okolisa>

<https://hrcak.srce.hr/io>

ISSN 1849-4714 (Print)

ISSN 1849-5079 (Online)

UDK 62:502/504



The journal "ENVIRONMENTAL ENGINEERING - INŽENJERSTVO OKOLIŠA" is active journal with updated content in the portal of the Croatian scientific and professional journals "Hrčak".

The logo is visible in the journal footer: <https://hrcak.srce.hr/io>



From November 2019 the journal "ENVIRONMENTAL ENGINEERING - INŽENJERSTVO OKOLIŠA" has become member of Crossref and all articles starting from Vol.6 (2019) will have assigned DOI number.

**Open access articles with assigned DOIs are available at:** <https://hrcak.srce.hr/io>

**Journal is indexed and included in:**



CASSI - Chemical Abstracts Service Source Index

**Printed by:** TISKARA ZELINA d.d., K.Krizmanić 1, HR-10380 Sveti Ivan Zelina, Hrvatska

**Edition:** 200 copies

**Front cover photo:** Posted photo show out Zagreb Cathedral's damage in major M5.5 earthquake on 22 March 2020. It was provided by architect Marko Dabrović.

**Back cover photo:** Courtesy of American Concrete Institute (ACI) Technical Committee 133 Disaster Reconnaissance task force members Jun. Prof. Dr.-Ing. Lars Abrahameczyk and Davorin Penava, Ph. D., Associate Professor, coordinated by Professor Santiago Pujol from Purdue University, Indiana, U.S. Posted photograph shows out-of-plane failure of masonry infill walls of reinforced concrete frame building occurred during M6.4 earthquake on November 26, 2019 in Durrës, North-Western Albania.



Sveučilište u Zagrebu  
GEOTEHNIČKI FAKULTET



## IMPRESSUM

### Publisher:

FACULTY OF GEOTECHNICAL ENGINEERING, UNIVERSITY OF ZAGREB  
Hallerova aleja 7, HR - 42000 Varaždin  
Tel.: + 385 (0)42 408 900  
Fax: + 385 (0)42 313 587  
E - mail: [ured.dekana@gfv.unizg.hr](mailto:ured.dekana@gfv.unizg.hr)  
URL: <http://www.gfv.unizg.hr>

### Editorial address:

FACULTY OF GEOTECHNICAL ENGINEERING, UNIVERSITY OF ZAGREB  
Hallerova aleja 7, HR - 42000 Varaždin  
Tel.: + 385 (0)42 408 911  
Fax: + 385 (0)42 313 387  
E - mail: [casopis@gfv.unizg.hr](mailto:casopis@gfv.unizg.hr)  
URL: <https://www.gfv.unizg.hr/static/casopis-inzenjerstvo-okolisa>; <https://hrcak.srce.hr/io>

## EDITORIAL TEAM

### Editor-in-Chief:

Nikola Sakač; *University of Zagreb, Faculty of Geotechnical Engineering, Varaždin, Croatia*

### Co-Editor:

Bojan Đurin; *University North, Department of Civil Engineering, Varaždin, Croatia*

### Technical Editor:

Davor Stanko; *University of Zagreb, Faculty of Geotechnical Engineering, Varaždin, Croatia*

### Assistant Editors:

Ranko Biondić; *University of Zagreb, Faculty of Geotechnical Engineering, Varaždin, Croatia*  
Ivana Grčić; *University of Zagreb, Faculty of Geotechnical Engineering, Varaždin, Croatia*  
Boris Kavur; *University of Zagreb, Faculty of Geotechnical Engineering, Varaždin, Croatia*  
Anita Ptiček Siročić; *University of Zagreb, Faculty of Geotechnical Engineering, Varaždin, Croatia*  
Zvezdana Stančić; *University of Zagreb, Faculty of Geotechnical Engineering, Varaždin, Croatia*

### Associated Editors:

Božidar Biondić; *University of Zagreb, Faculty of Geotechnical Engineering, Varaždin, Croatia*  
Mario Gazdek; *University of Zagreb, Faculty of Geotechnical Engineering, Varaždin, Croatia*  
Marija Jozanović; *Josip Juraj Strossmayer University of Osijek, Department of Chemistry, Osijek, Croatia*  
Roberto Linares; *Institute of Physics, Universidade Federal Fluminense, Rio de Janeiro, Brasil*  
Paulo Lopes; *University of Aveiro, Department of physics, Aveiro, Portugal*  
Sanja Kapelj; *University of Zagreb, Faculty of Geotechnical Engineering, Varaždin, Croatia*  
Natalija Koprivanac; *University of Zagreb, Faculty of Chemical Engineering and Technology, Zagreb, Croatia*  
Sanja Kovač; *University of Zagreb, Faculty of Geotechnical Engineering, Varaždin, Croatia*  
Elvira Kovač-Andrić; *Josip Juraj Strossmayer University of Osijek, Department of Chemistry, Osijek, Croatia*  
Snježana Markušić; *University of Zagreb, Faculty of Science, Zagreb, Croatia*  
Hrvoje Meaški; *University of Zagreb, Faculty of Geotechnical Engineering, Varaždin, Croatia*  
Davorin Penava; *Josip Juraj Strossmayer University of Osijek, Faculty of Civil Engineering and Architecture Osijek, Croatia*  
Igor Petrović; *University of Zagreb, Faculty of Geotechnical Engineering, Varaždin, Croatia*  
Mohamed El Shimy; *Ain Shams University, Faculty of Engineering, Kairo, Egipt*  
Stjepan Strelec; *University of Zagreb, Faculty of Geotechnical Engineering, Varaždin, Croatia*  
Mirna Habuda Stanić; *Josip Juraj Strossmayer University of Osijek, Faculty of Food Technology, Osijek, Croatia*  
Radmila Šalić; *Institute of Earthquake Engineering and Engineering Seismology, Skopje, Republic of the North Macedonia*  
Renato Šarc; *Montan University Leoben, Leoben, Austria*  
Bojan Šarkanj; *University North, Department of food technology, Koprivnica, Croatia*  
Mario Šiljeg; *Ministry of Environment and Energy, Croatia*  
Branka Trček; *University of Maribor, Faculty of Civil Engineering, Transportation Engineering and Architecture, Slovenia*

### Statistical and Metrological Editor:

Ivan Kovač; *University of Zagreb, Faculty of Geotechnical Engineering, Varaždin, Croatia*

### Language adviser:

Ana Jelčić; *University of Zagreb, Faculty of Geotechnical Engineering, Varaždin, Croatia*

### Technical staff:

Dragana Dogančić; *University of Zagreb, Faculty of Geotechnical Engineering, Varaždin, Croatia*  
Jasmin Jug; *University of Zagreb, Faculty of Geotechnical Engineering, Varaždin, Croatia*  
Ivana Melnjak; *University of Zagreb, Faculty of Geotechnical Engineering, Varaždin, Croatia*  
Marko Petric; *University of Zagreb, Faculty of Geotechnical Engineering, Varaždin, Croatia*

## Editor-In-Chief opening remarks

Dear readers,

It is a great honor to introduce you the new Issue Topic: ENVIRONMENTAL HAZARDS number of the journal *Environmental Engineering-Inženjerstvo okoliša* published by the Faculty of Geotechnical Engineering, University of Zagreb, Croatia.

This number was a spontaneous response to the heavy earthquake in Albania in late 2019. During the issue progress, another two events marked a year 2020; a COVID-19 pandemic and a heavy earthquake in the City of Zagreb, the capital of Croatia.

For this reasons, we had an honor to guest two extraordinary scientists, professionals in the field of earthquake engineering: Guest Editors prof. Lars Abrahamczyk from Bauhaus-Universität Weimar, Germany and prof. Davorin Penava from the University of Osijek, Faculty of Civil Engineering and Architecture Osijek, Croatia, who have done a remarkable effort to bring the topic of environmental hazards closer to the readers.

The final results are 6 papers, including 2 review papers, 2 original scientific papers and 2 professional papers, including authors from 6 different institutions and three papers in international co-authorship.

The papers covered different fields – the retrospective paper dedicated to the lecture (in 1909) of a famous Croatian geophysicist prof. Andrija Mohorovičić (1857 – 1936) and his 15 rules how to build earthquake-resistant buildings, with the comments on Zagreb earthquake; then the architectural and engineering design criteria for earthquake resistant masonry infilled RC frames containing openings; the use of Landsat satellite recordings in visualization and detection of thermal islands; methods for reducing the environmental impact of rock mass excavation, ancient city in Uzbekistan and the integration of natural elements into the traditional house for the climate improvement.

Even though the environmental hazards are negative events, I hope this issue will be a small contribution to the advances in earthquake engineering and environmental engineering in general.

At the end, I would like to give my gratitude to prof. Lars Abrahamczyk and prof. Davorin Penava, all hard working team members and to our sponsors.

I hope you will enjoy it.

With best regards,



**Assoc. Prof. Dr. Nikola Sakač**  
Editor-in-Chief

Unit for Chemical Sensors  
Department of Environmental Engineering  
Faculty of Geotechnical Engineering  
University of Zagreb  
Croatia

## Guest Editor introduction

Dear Colleagues,

the Guest editors of the Issue Topic entitled *Environmental Hazards* of journal *Environmental Engineering* primarily intended to bring attention to M6.4 earthquake event occurred on November 26, 2019 in North-western Albania. A significant disaster event in the region. The Guest editors, scientists in the field of earthquake engineering, were participating in the reconnaissance mission in the city of Durrës (Albania) as members of the American Concrete Institute (ACI) Technical Committee 133 Disaster Reconnaissance task force, coordinated by Professor Santiago Pujol from Purdue University, Indiana, U.S. The goal of the mission was to increase the understanding of earthquake resistance of masonry infilled reinforced concrete frame buildings. However, during the preparation of this Issue Topic the M5.5 earthquake event occurred on March 22, 2020 in the City of Zagreb and its surroundings. Therefore, it was decided that the latter presents this issue in the front cover (Zagreb Cathedral), while the North-western Albania earthquake is presented on the back cover.

This issue is consisted mainly, but not only, from papers made by authors from Central Asia in the framework of the ERASMUS+ programme – Key Activity 2 project entitled *Environmental risk assessment and mitigation on Cultural Heritage assets in Central Asia* (Reference: 609574-EPP-1-2019-1-IT-EPPKA2-CBHE-JP) coordinated by Professor Fulvio Rinaudo, Polytechnic of Turin, Italy, in which the guest editors are participating as well.

Efforts have been made to make this issue international, although it had been inevitably enriched by the authors from Croatia. The main goal was to increase the awareness of the society to disasters and corresponding needs, in order to consider them in the future development and to improve the quality of construction. The Issue Topic provides some overall insights in past design, with reflection to M6.3 1880 Zagreb earthquake, recommendations made by Professor Andrija Mohorovičić (1857-1936) as decisions for the future, and recent Zagreb earthquake consequences. Additionally, it represents a marking of a fruitful research collaboration between Bauhaus-Universität Weimar, Earthquake Damage Analysis Centre (EDAC) and Josip Juraj Strossmayer University of Osijek, Faculty of Civil Engineering and Architecture Osijek, over many years.

Guest editors express their gratitude to authors for their valuable work. Special thanks are owed to Journal Editor-in-Chief Associate Professor Nikola Sakač, Technical Editor Davor Stanko Ph. D. and their team for support and advices in carrying out this Issue Topic.

Yours sincerely,



**Jun. Prof. Dr.-Ing. Lars Abrahamczyk**  
Chair of Advanced Structures  
Bauhaus-Universität Weimar  
Germany



**Assoc. Prof. Dr. Davorin Penava**  
Josip Juraj Strossmayer University of Osijek  
Faculty of Civil Engineering and Architecture  
Osijek, Croatia

---

## C O N T E N T

- Davor Stanko, Snježana Markušić, Davorin Penava**  
**BACK TO THE FUTURE – ANDRIJA MOHOROVIČIĆ LECTURE (1909) & ZAGREB (2020) M5.5 EARTHQUAKE** 1  
*Review paper*
- Davorin Penava, Daniel Alejandro Arciniega Larrea, Filip Anić, Lars Abrahamczyk**  
**ARCHITECTURAL AND ENGINEERING DESIGN CRITERIA FOR EARTHQUAKE RESISTANT MASONRY INFILLED RC FRAMES CONTAINING OPENINGS** 11  
*Review paper*
- Ivana Petrinjak, Nikola Kranjčić, Milan Rezo, Bojan Đurin**  
**POSSIBILITY OF USING LANDSAT SATELLITE RECORDINGS IN VISUALIZATION AND DETECTION OF THERMAL ISLANDS IN THE AREA OF THE CITY VINKOVCI** 18  
*Original scientific paper*
- Jasmin Jug, Kristijan Grabar**  
**METHODS FOR REDUCING THE ENVIRONMENTAL IMPACT OF ROCK MASS EXCAVATION** 29  
*Original scientific paper*
- Gavkhar Durddiyeva, Adilbek Zargarov, Ergashbek Salayev**  
**ANCIENT CITY CONNECTED WITH THE NAME OF THE WELL “KHEYVAQ”** 39  
*Professional paper*
- Bonu Azizova, Anna Osello**  
**INTEGRATION OF NATURAL ELEMENTS INTO THE TRADITIONAL HOUSE (OF KHOREZM REGION, UZBEKISTAN) FOR THE CLIMATE IMPROVEMENT** 43  
*Professional paper*

# BACK TO THE FUTURE – ANDRIJA MOHORVIČIĆ LECTURE (1909) & ZAGREB (2020) M5.5 EARTHQUAKE

Davor Stanko<sup>1\*</sup>, Snježana Markušić<sup>2</sup> & Davorin Penava<sup>3</sup>

<sup>1</sup> University of Zagreb, Faculty of Geotechnical Engineering, Hallerova aleja 7, HR-42000, Varaždin

<sup>2</sup> University of Zagreb, Faculty of Science, Geophysical Department, Horvatovac 95A, HR-10000, Zagreb

<sup>3</sup> Josip Juraj Strossmayer University of Osijek, Faculty of Civil Engineering and Architecture Osijek, Vladimir Prelog 3, HR-31000, Osijek

\*E-mail of corresponding author: davor.stanko@gfv.unizg.hr

**Abstract:** This review paper relates original Mohorovičić, A. lecture *DJELOVANJE POTRESA NA ZGRADE* (1909, 1911) and its English translation *EARTHQUAKE EFFECTS ON BUILDINGS* (2009) with M5.5 Zagreb 2020 earthquake damage. Mohorovičić said in Introduction of his lecture in 1909: “another strong earthquake is needed to remind people that the building techniques should be further developed and improved...”. Oliver Wendell Holmes (1809-1894) said once: “The young man knows the rules, but the old man knows the exceptions”. This should remind us that going **Back to the Future** after strong earthquake, we must go **Back to the Past**, and look after **Mohorovičić’s 15 rules how to build earthquake-resistant buildings**. He tells us how to build, and unfortunately, we were left unprepared again and didn’t listen wisdom words of an “old man”.

**Keywords:** Andrija Mohorovičić lecture, Zagreb 2020 earthquake, Djelovanje potresa na zgrade, Earthquake effects on buildings.

Received: 05.05.2020. / Accepted: 03.06.2020.

Published online: 10.07.2020.

Review paper

<https://doi.org/10.37023/ee.7.1.1>

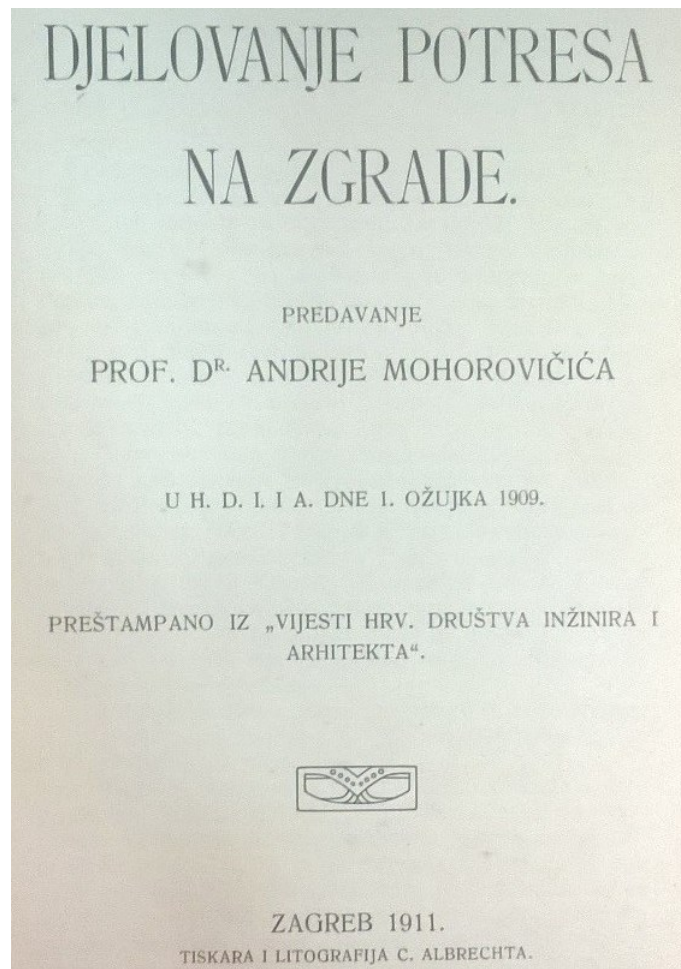

**Figure 1.** Effects of earthquakes on buildings. Lecture given by Professor Andrija Mohorovičić, Ph. D. at the Croatian Society of Engineers and Architects (CSEA) on March 1st, 1909

## 1. BACK TO THE PAST – WHAT WAS ANDRIJA MOHOROVIČIĆ TELLING US...

"... Systematic study of earthquakes has also one very practical aspect. Strong earthquakes often cause great damage to houses and other buildings, and occasionally they level to the ground large and rich cities and bury thousands of people under the ruins. Therefore, one of the most important goals of seismology is to theoretically study how the movement of the earth affects buildings, and to apply these results as well as the experience gained in catastrophic earthquakes to show the ways of constructing buildings resistant as much as possible against earthquakes...." (Mohorovičić 1913, 2009; Herak & Herak 2009).

"...In order to study earthquake effects on buildings, we must first accurately represent the shaking of soil beneath the building, as well as the forces the shaking exerts, and then we must study how these forces affect the building as a whole and its individual parts..." (Herak & Herak 2007)

"...I take this opportunity to warn all responsible institutions of outdated building codes, which completely disregard the ways earthquakes affect buildings. In March of this year (1909) I have delivered a lecture on that subject in the Society of Engineers and Architects in Zagreb, and I stressed the need to consider earthquakes when buildings are constructed, I will soon publish the extended edition of the lecture (Figure 1, 2). So far, my appeals fell on deaf ears; after the lecture, many buildings were erected in Zagreb that pose threat for passers-by, as well as to themselves...." (Mohorovičić 1909, 1911, 2009; Herak & Herak 2009).

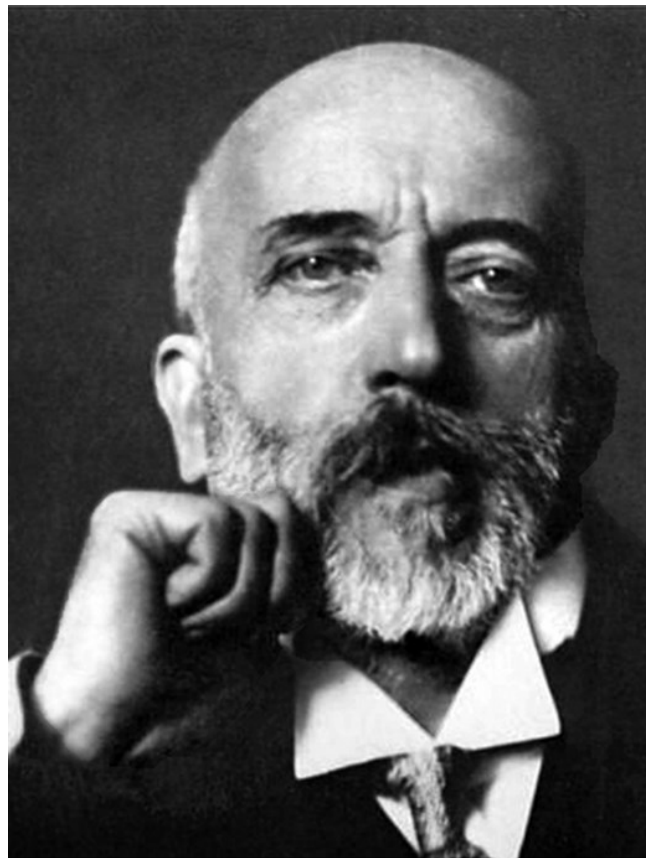

**Figure 2.** Dr. Andrija Mohorovičić (1857-1936), geophysicist of the world renown and one of the greatest Croatian scientists of all times

## 2. BACK TO THE FUTURE – 22 MARCH 2020 ZAGREB EARTHQUAKE

"...After each major earthquake, in the engineering circles one discusses the damage which affected the buildings during the catastrophe, and possible means of prevention against the damage. From these discussions, many ideas usually emerge on alterations which should be introduced into the traditional building ways. But such is the human nature that, as soon as the first fears are over the feeling of security prevails, and nobody considers any further changes; moreover, even those which have been accepted immediately after an earthquake get forgotten. Another strong earthquake is needed to remind people that the building techniques should be further developed and improved..." (Mohorovičić 1909, 1911, 2009).

At approximately 6:24 CET on the Sunday morning of 22 March 2020, a 5.5 magnitude earthquake struck Zagreb, Croatia, with an epicenter 7 km north of Zagreb city centre. The maximum felt intensity was VII (Very strong) on the Modified Mercalli intensity scale (Figure 3), or VII-VIII °MCS (Mercalli-Cancani-Sieberg) scale.



It was felt all over Croatia, even at distances of more than 1000 km from the epicenter. After about 15 seconds of intense shaking, nothing will be in Zagreb as it was before. People did not even manage to be prepared, the vast majority were just preparing to leave their homes when another powerful earthquake occurred at 7 hours and 1 minute. This time of magnitude 5.0 according to Richter. The third strong shaking was recorded at 7 hours and 41 minutes, earthquake with magnitude 3.7 according to Richter. In just over 24 hours since the main shock, 57 earthquakes with magnitudes greater than or equal to 2.0 happened in Zagreb (Markušić et al. 2020).

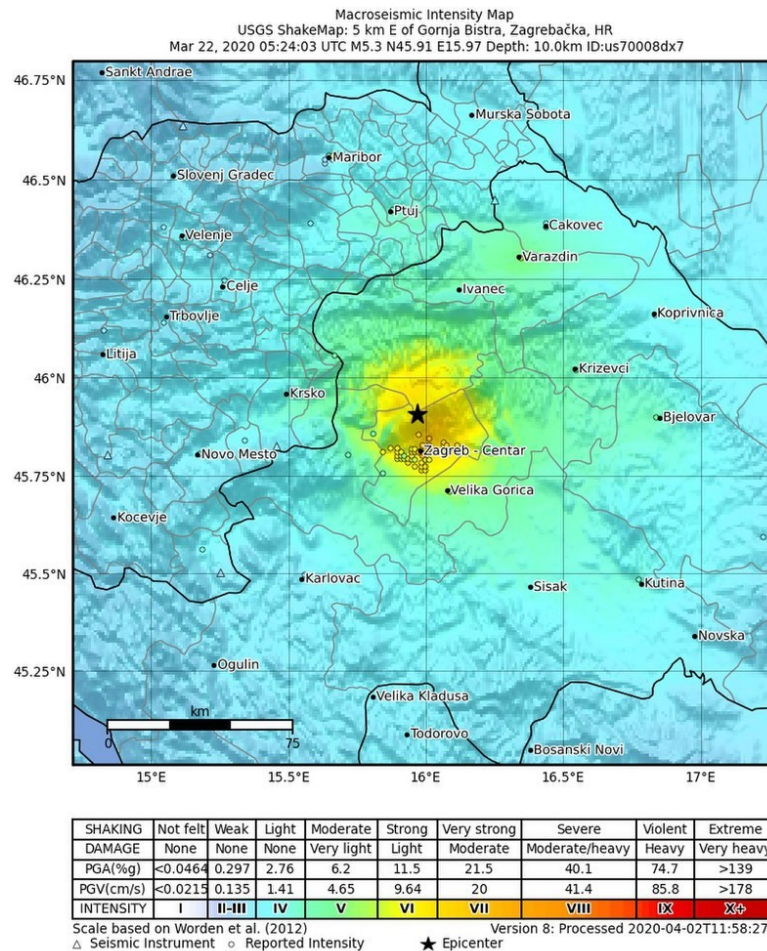
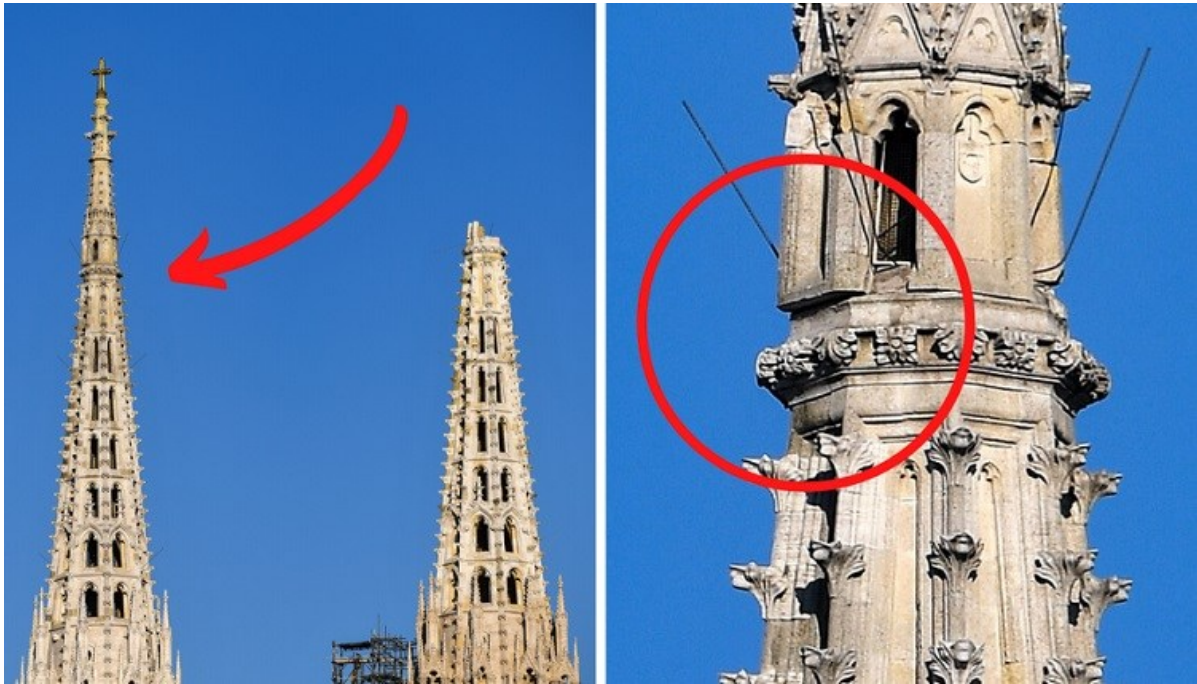

**Figure 3.** Macroscopic intensity map of the 2020 main earthquake in Zagreb, Croatia.  
<https://earthquake.usgs.gov/earthquakes/eventpage/us70008dx7/shakemap/intensity>

The main shock was the strongest earthquake in Zagreb since the "Great Zagreb 1880 earthquake" and caused substantial damage in the historical city center. All were stunned with the damage of the top of the Cathedral's south tower (Figure 4). A numerous damage to the cultural and historical architectural heritage of the City of Zagreb have been reported (Figure 5). Many churches were heavily damaged (Figures 6 & 7) as well as the Croatian Parliament building. Most of the museums and theatres in the city's centre suffered also serious damage (e.g., the Museum of Arts and Crafts, the Croatian History Museum, the Schools Museum, Komedia Theatre, the Croatian National Theatre). Over 1,900 buildings (up to now) are reported to have become uninhabitable by the earthquake damage, particularly buildings built before 1964. In places around the epicenter, the situation was very bad because of the destroyed houses (Figure 8) (Markušić et al. 2020).

**The earthquake occurred during the 2020 coronavirus pandemic.** It must be stressed out that this was lucky coincidence for citizens of Zagreb due to coronavirus lockdown restrictions and Sunday morning earthquake event when people were still sleeping, resulting in only 27 injured people and, unfortunately, one teenage girl died from her injuries.

Croatian government and Zagreb city administration presented plans and new law for the renovation of the damaged structures, but as Mohorovičić (1909, 1911, 2009) said "...such is the human nature that, as soon as the first fears are over the feeling of security prevails, and nobody considers any further changes; moreover, even those which have been accepted immediately after an earthquake get forgotten...", we must stress out importance that we all (people, government, engineers, scientists) need to learn from this M5.5 earthquake "mistakes" and closely work together for the future events. The damage occurred to various kinds of buildings is shown in Figures 4 to 8. More figures about earthquake damage in Zagreb can be seen in the Appendix.



**Figure 4.** Damage of the top of the Cathedral's south tower. North tower was removed to limit further damage from aftershocks on 17 April 2020.

<https://www.24sata.hr/news/pogledajte-kako-se-pomaknuo-toranj-za-cak-12-centimetara-684927/galerija-624839>  
<https://www.poslovni.hr/hrvatska/foto-danas-se-sigurno-krece-u-rusenje-tornja-katedrale-4226919>



**Figure 5.** Damage in Zagreb after 22 March M5.5 earthquake. Noticeable roof tile loss and chimney collapse

<https://narod.hr/hrvatska/foto-video-pogledajte-fotografije-nakon-potresa-u-zagrebu-srusio-se-vrh-katedrale>

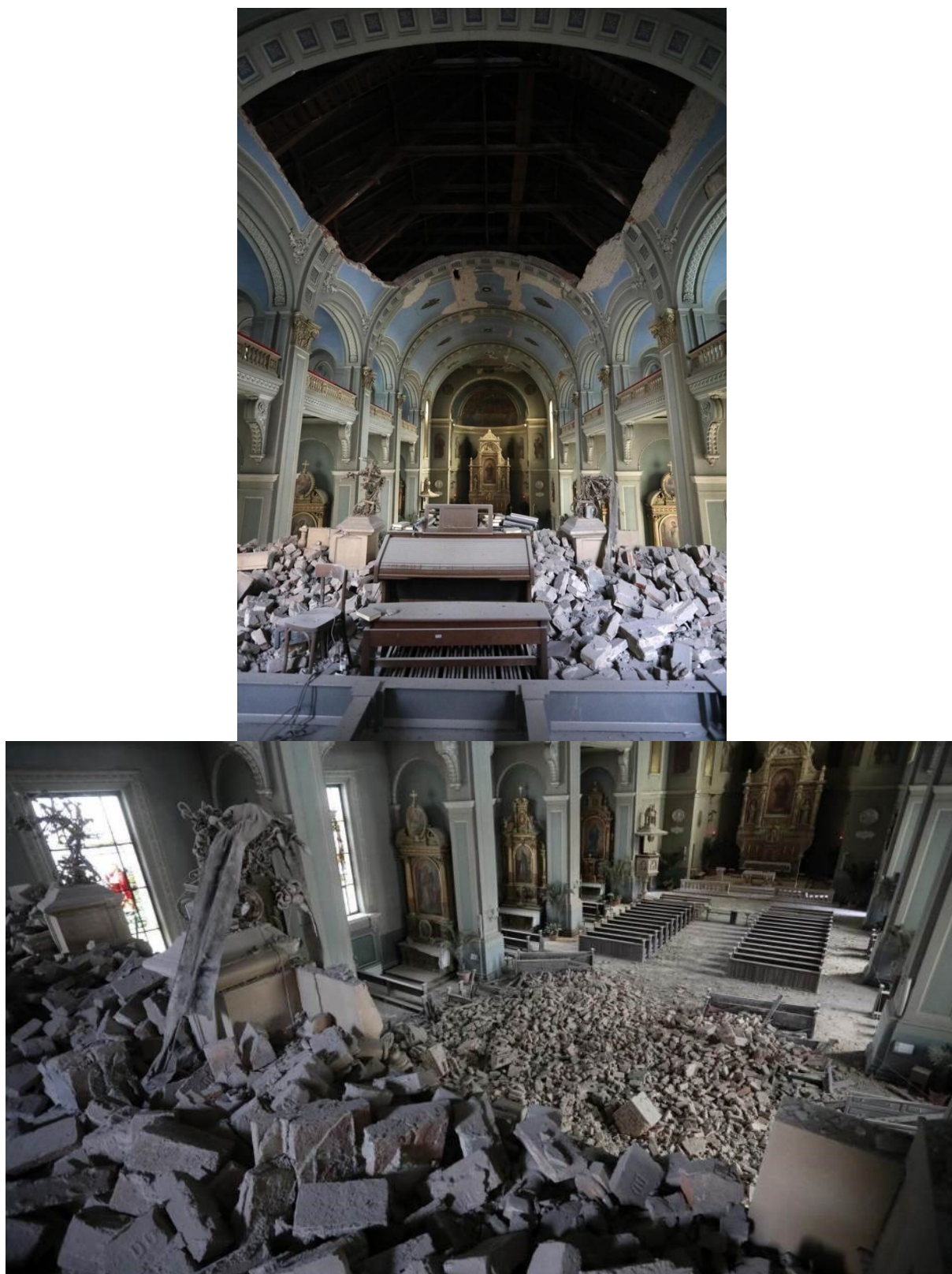

**Figure 6.** Damage to cultural heritage: Basilica of the Heart of Jesus from 1902  
<https://www.24sata.hr/news/crkva-u-palmiticevoj-unistena-urudio-se-strop-iznad-ulaza-682556>

The problem of building performance, as observed in **Figures 4 to 8**, lies partially in inadequate design with respect to corresponding seismic demand, and in other part in lack of implementation, or lack in general, of available research solutions for their protection (e.g. the heritage building Shrine of Saint Mary of Remete dating from 1786 shown in **Figure 7** was already once severely damaged in 1880 Zagreb earthquake). For the seismic safety purposes, it is therefore required to adopt and enforce the seismic rules and regulations (e.g. see **Table 1**), with particular attention to cultural heritage sites.



**Figure 7.** Damage to cultural heritage: Shrine of Saint Mary of Remete from 1786  
<https://www.24sata.hr/news/pogledajte-trenutak-potresa-u-crkvi-u-remetama-u-zagrebu-682565>



**Figure 8.** Heavily damaged family house near the epicenter.  
<https://dnevnik.hr/vijesti/hrvatska/potres-u-zagrebu-ostali-bez-domova---598777.html>

### 3. BACK TO THE PAST FOR THE FUTURE – HOW TO BUILD EARTHQUAKE-RESISTANT BUILDINGS

Mohorovičić introduced concepts of seismic hazard and earthquake risk for the city of Zagreb (Mohorovičić 1909, 1911, 2009; Herak & Herak 2009):

*“...There are **two sources of mistakes** which would seriously endanger our buildings. The first come from ignoring the ways the earthquake affects the buildings; the other is the inadequate construction process.*

*Many properly executed buildings are not safe against earthquakes, simply because their foundations were made without considering the **earthquake hazard**. Investigating the damage on buildings from some major earthquakes during recent years, I obtained results which confirm that some general rules can be formulated. Every contractor should take these rules into account when planning the buildings, especially the very tall ones, and the buildings designed in agreement with these rules would be almost completely safe against earthquakes. **One cannot speak of the absolute safety, because it is not known how strong the strongest earthquake can be, and probably it is not even possible to construct the building which would not be damaged by an exceptionally strong earthquake.***

- 1. It is not possible to construct a building which would be safe against all possible effects of a catastrophic earthquake. If the ground beneath the building cracks, the building on it must crack too. If the ground collapses, so must the building; if the steep short waves develop on the earth's surface, the building will either crack or be destroyed.*
- 2. By using common material a building can always be constructed which will resist all, even the strongest, earthquakes which occur in our country (up to the maximal horizontal acceleration of 2000 mm/s<sup>2</sup>).*

*From the data collected in the past, one can determine **the probability of strong earthquakes** in Croatia and Slavonia. In the last 50 years 91 strong earthquakes occurred in our region. Of these 57 earthquakes were in the Zagreb and Varaždin counties, 20 in Primorje and 30 in the Požega county. On the mountain of Medvednica (Zagrebačka gora) there were 30 of them. It follows that in the surroundings of Mt. Medvednica, including the city of Zagreb, three strong earthquakes occur every five years.*

*In the last 25 years there were 3 to 4 earthquakes which induced damage, and a disastrous one in the year 1880 with great damage. In the more distant past, the earthquake of March 26th 1502 is mentioned, when the tower of St. Mark's collapsed, the other one of the year 1590 when the Medvedgrad Castle was destroyed, of 1699 when again the tower of St. Mark's was destroyed, and another one of July 1st 1756. It is hard to estimate whether these earthquakes were stronger or weaker than the 1880 earthquake. **These data show that in Zagreb we have one very strong earthquake each 100 years, one weaker but damaging earthquake every 10 years, and 3 moderate earthquakes within every 5 year. It is assumed that an ordinary building has a duration of 150 to 200 years.***

*During its lifetime this building will have to withstand one very strong earthquake, about 100 moderate earthquakes, 100 weaker earthquakes and 1500 to 2000 very weak earthquakes, whose origin lies below the town of Zagreb or very near to it...”*

*If we add those earthquakes which have their foci in the greater Zagreb area, and whose shaking is also felt in Zagreb, then the numbers we obtain are very large.*

*It follows that the **danger of earthquakes must be carefully considered** when building houses in Zagreb, and that it is profitable to pay more in order to make the building as safe against the earthquake as possible.*

***The safer our buildings will be, the lower will be the credit interests for such buildings, and the town will grow and develop faster if the foreign guests will be free of fear of earthquakes.***

*The building codes for the town of Zagreb contain several rules having the purpose to secure the building from the earthquake hazards. Nevertheless, there are still many mistakes in the ways of constructing the buildings which can be avoided without increasing the costs; there are some which could be easily avoided with only slightly increased costs, taking into account also the purpose the building will serve, and the durability it was designed for.*

*I decided to use these lines to explain to the highly esteemed gentlemen builders and contractors about the ways how the earth is trembling and how this trembling affects the buildings, and to stress some principles which every architect and every contractor should have in mind when building our houses...”*

Mohorovičić analyzed most common building elements, building types, their resistance and response to earthquake shaking (full details in Mohorovičić 1911, 2009.) and draw **15 Mohorovičić's rules how to build earthquake-resistant buildings** (Table 1) that are still valid and applicable and most importantly to say, they are comparable with the basic principles of conceptual design from Eurocode-8 (2004).

**Table 1.** Mohorovičić's 15 rules how to build earthquake-resistant buildings from 1911

Rule #	In Croatian (Mohorovičić 1911; Herak 2020)	In English (Mohorovičić 2009)
1	<i>Na strmim, a osobito na gornjem rubu strmine neka se uopće ne gradi.</i>	<i>On the steep slopes, especially on the upper edge of a steep incline no building should be built.</i>
2	<i>Pomno ispitati zemljište, ako treba umjetno ga pojačati.</i>	<i>The soil at the site where the building is planned should be carefully examined before the construction starts. If necessary, the ground should be artificially reinforced.</i>
3	<i>Temelji zgrade neka su tako jaki i debeli, da bude pritisak na zemlju po jedinice plohe, po mogućnosti malen.</i>	<i>The foundation of the building should be strong and thick, in order to make the compression on the ground per unit of area as small as possible.</i>
4	<i>Temelj zgrade neka je po mogućnosti monolit napravljen od betona koji se može ojačati umetanjem jake željezne šipke.</i>	<i>The foundation of the building should be a monolith, best made of concrete (large pieces of rocks are allowed in concrete). If the builder has any doubts concerning the quality of the ground, he should reinforce the foundation wall by inserting into it lengthwise a long and strong iron bar.</i>
5	<i>Ako je zgrada monolit, onda je time otpornija, čim su joj stijene tanje. Kod proračunavanja debljine osnovnih zidova, pregradni se mogu zanemariti.</i>	<i>If the building is a monolith, and it is constructed so that it can be regarded as a single hollow column, the thinner are its walls, more resistant against the earthquake it will be. The thickness of the walls then depends only on the load it will have to bear i.e. on the weight of ceilings, roof and the other loads. By calculating the thickness of the walls the weight of the dividing walls need not be taken into account.</i>
6	<i>Radi smanjenja lateralnih deformacija valja graditi krute stupove i krovove čvrsto povezane s nosivim zidovima.</i>	<i>In order that the building be considered a single hollow column, all the walls have to be built so that any deformation in the horizontal direction should be hindered as much as possible.</i>
7	<i>Vatrobrani zid mora biti jednako čvrst kao i svi ostali zidovi i jednako čvrsto vezan sa stropovima i krovom.</i>	<i>Since one of the most important walls is the firewall, it has to be equally solid as all the others, and equally strongly connected with the ceilings and the roof.</i>
8	<i>Čim bude u umutrašnjosti zgrade više čvrstih poprečnih zidova, tim će zgrada biti čvršća.</i>	<i>More transversal strong walls the building will have, the stronger it will be.</i>
9	<i>Sve svodove valja zamijeniti gredama jer svodovi rastežu, a grede vežu zidove.</i>	<i>All the arches, wherever possible, should be replaced by the transversal beams, because the arches stretch the walls, and the beams bind them together.</i>
10	<i>Smanjiti na minimum sve dijelove zgrade koji ne doprinose čvrstoći (što lakša stubišta i pregradne stijene, izbjegavati teške ukrase).</i>	<i>All parts of the building which do not serve to increase its strength should be reduced to a minimum. The stairways should be as light as possible, and the same is valid for the separating walls. Any unnecessary heavy ornaments especially on the roof should be removed.</i>
11	<i>Prigradnje i krila zgrade neka se ili veoma čvrsto vežu s glavnom zgradom, ili neka se grade posebne neovisne zgrade.</i>	<i>Attachments and wings should either be strongly connected to the main building (taking care about the inner corners) or should be built as separate independent buildings.</i>
12	<i>Svakovrsne izbočine na zgradi, ako ih već mora biti, neka budu vezane s poprečnim zidovima, te po mogućnosti lake i čvrste.</i>	<i>Various protuberances on the building, if they are really necessary, should be linked with the transversal walls and be made as light and strong as possible.</i>
13	<i>Krov neka je lagan, čvrst i čvrsto vezan sa svim zidovima. Ravni se krovovi preporučuju za seizmički jako aktivna područja.</i>	<i>The roof should be light, strong and, tightly connected with all walls. The flat roofs are especially recommended for the regions often subjected to strong earthquakes.</i>
14	<i>Dimnjaci neka su čim lakši i čim čvršći, čvrsto vezani s krovom.</i>	<i>The chimneys must be light and strong in the vertical direction. Where passing through the roof, they should be strongly connected with it. The height of the chimneys above the roof must not exceed 60 cm. If the higher chimneys must be built, their top must be tied to the roof on all four sides.</i>
15	<i>Da kod potresa ne pada crijep sa zgrade na ulicu, neka se na rub krova metne rešetka od željeza.</i>	<i>Iron railings should be mounted on the edges of the roof to prevent the roof tiles from falling into the street during an earthquake.</i>

With respect to **Figures 4 to 8** and Mohorovičić's 15 advices stated in **Table 1**, one can easily correlate e.g. rules 10 to 15 with building damage in **Figure 5** or rules 6 to 9 with building damage in **Figure 8**. **The cultural heritage buildings as those in Figures 4, 6 and 7, are very sensitive and require multidisciplinary approach.** The obstacles in effective implementation of the earthquake risk reduction rules (such as those stated in **Table 1**) arise when dealing with existing built environment. The detail and degree to which building's seismic performance could be improved for expected future events, meets the technical and non-technical obstacles. The latter is related unwillingness and/or inability due to lack of initiative, lack of finances or in general the lack of proper understanding of earthquake and its consequences. The technical part i.e. knowledge on building construction

methods and design, is increasing over the years due to significant research effort. In the case of new “starting from scratch” buildings, the potential problems of complete implementation of rules are in the obstruction of design and construction (e.g. less building material used, project modifications without authorization, non-enforcement of regulations etc.). The earthquake risk is a worldwide problem and its mitigation is related to the nature and the socio-economic character of the buildings and people.

#### 4. CONCLUSIONS

If we go **Back to the Past** and carefully read Andrija Mohorovičić’s words “*After each major earthquake... possible means of prevention against the damage... immediately after an earthquake get forgotten... another strong earthquake is needed to remind people that the building techniques should be further developed and improved...*”, points out that going **Back to the Future** after strong earthquake without looking **Back to the Past**, will result in exactly what we witnessed after the M5.5 Zagreb 2020 earthquake – substantial damage of cultural and historical architectural heritage of the City of Zagreb.

**So unfortunately, 140 years after the Great 1880 Zagreb earthquake we were left unprepared again...**

Cultural heritage, as “every material and immaterial evidence of the cultural identity of a population” is considered not only for its immediate economic value related to tourism and for its immaterial value of witness of the past, but also in a wider context as a fundamental element to maintain and promote cultural identities and differences, recognizing this as a potential instrument of progress and cooperation and as a primary component of the quality of life of citizens.

Earthquakes cause considerable damage to historical centers as we observed from **the PAST** Zagreb earthquakes, so that a suitable prevention policy is necessary to guarantee their conservation for **the FUTURE**. The first step is getting a complete knowledge of the area of interest and of the existing structures. In the selected areas, a detailed analysis to understand the characteristics of the seismic input through the analysis of seismic hazard and microzoning is needed. Also the seismic performance of buildings should be monitored in order to assess their seismic response.

Earthquakes with a very high magnitude occur relatively infrequently, most often repeatedly in certain regions in tectonically active zones. The collaboration of multidisciplinary teams (seismologists, geologists, geotechnical engineering, civil engineers, earthquake engineers, constructors, architects) is necessary. It is necessary that we work together as a multidisciplinary team: And finally, if we want that these teams work, they need strong support from the government. The social and economic cost of natural disaster like earthquake is increasing with each event. For this reason, it is important that seismic risk analysis should be made using all available information for specific earthquake event that may occur: seismic hazard, people exposure, location of the exposure related to the hazard and finally vulnerability of the people and building exposure at the hazard location. Pre-disaster event measures and activities; prevention, mitigation, preparedness, readiness, as well post-disaster event measures and activities; response, recovery and development are all related to seismic hazard-disaster-risk circle (Milutinović & Šalić 2004). **Concepts of seismic hazard and earthquake risk for the city of Zagreb has been introduced by Andrija Mohorovičić in such a way that 111 years later, there is little one could add or improve.**

*Let’s finally listen the wisdom words of an “old man”.*

#### 5. REFERENCES

- EN 1998-1 (2004): Eurocode 8: Design of structures for earthquake resistance – Part 1: General rules, seismic actions and rules for buildings [Authority: The European Union Per Regulation 305/2011, Directive 98/34/EC, Directive 2004/18/EC]
- Herak M, Herak D (2007) Andrija Mohorovičić (1857– 1936) was born 150 years ago. Newsletter - New Zealand Geophysical Society, 73, 27-29.
- Herak M, Herak D (2009) Foreword to the English translation of Effects of earthquakes on buildings by A. Mohorovičić. Geofizika, 26 (1), 1-4.
- Herak M (2020) ANDRIJA MOHOROVIČIĆ: Ako je u unutrašnjosti zgrade više čvrstih poprečnih zidova, zgrada će biti čvršća. Večernji list-Panorama. 8. travnja 2020. 26-27
- Markušić S, Stanko D, Korbar T, Belić N, Penava N, Kordić B (2020) The Zagreb (Croatia) M5.5 earthquake on 22 March 2020. Geosciences. 252, 21. doi:10.3390/geosciences10070252
- Milutinović Z, Šalić R (2004) Planning for seismic risk reduction (S-107). Lecture notes from international twelve-week course on aseismic design and construction. CADAC 2004, October/November, Skopje.
- Mohorovičić A (2009) Effects of earthquakes on buildings. Geofizika, 26, 1–65 (English translation).
- Mohorovičić A (1913) Razvoj seizmologije posljednjih pedeset godina, Reprinted from Ljetopis JAZU, 27, Dionička tiskara, Zagreb, pp. 31.
- Mohorovičić A (1909, 1911) Djelovanje potresa na zgrade – predavanje prof. dr. Andrije Mohorovičića u H. D. I. A. dne 1. ožujka 1909, preštampano iz »Vijesti Hrv. društva inženira i arhitekta, Zagreb, Tiskara i litografija C. Albrechta, 79 pp.

APPENDIX: MORE FIGURES ABOUT 22 MARCH 2020 ZAGREB EARTHQUAKE



<https://www.rtl.hr/vijesti-hr/novosti/hrvatska/3670825/vise-od-90-potresa-zatreslo-zagreb-steta-ce-se-sanirati-godinama-imali-smo-srece/?galerija=2744137>



[https://www.muo.hr/blog/2020/03/22/muo\\_potres/](https://www.muo.hr/blog/2020/03/22/muo_potres/)



<https://www.tportal.hr/vijesti/clanak/velika-fotogalerija-uvjerite-se-iz-prve-ruke-u-posljedice-razornog-potresa-koji-je-pogodio-zagreb-foto-20200322>



# ARCHITECTURAL AND ENGINEERING DESIGN CRITERIA FOR EARTHQUAKE RESISTANT MASONRY INFILLED RC FRAMES CONTAINING OPENINGS

Davorin Penava <sup>1\*</sup>, Daniel Alejandro Arciniega Larrea <sup>2</sup>, Filip Anić <sup>1</sup>, Lars Abrahamczyk <sup>2</sup>

<sup>1</sup> Josip Juraj Strossmayer University of Osijek, Faculty of Civil Engineering and Architecture Osijek, Vladimira Preloga 3, 31000 Osijek, Croatia

<sup>2</sup> Bauhaus Universität Weimar, Earthquake Damage Analysis Center (EDAC), Marienstraße 13B, 99423 Weimar, Germany

\*E-mail of corresponding author: davorin.penava@gfos.hr

**Abstract:** In earthquake resistant design of RC frame structures, the definition of masonry infilled frame is often split between reinforced concrete and the masonry structures. However, it is known that the frame elements and the masonry wall work as a coupled system. Additionally, a dedicate chapter for the definitions of openings size, quantity and position is missing. The definition of a full, partial or non-masonry infilled frame with opening is not establish in engineering and architectural codes; rather, recommendations are given. A competent masonry infilled frame with openings would mean to correlate the architectural and engineering concepts as to define an engineered or non-engineered infilled wall. Likewise, certain boundaries should be established using both the architectural and engineering concepts to relate the importance of illumination and air ventilation product of the openings and masonry infilled frame failure patterns.

**Keywords:** Structural Masonry, Masonry Infilled Frames, Openings, Earthquake Engineering Design, Architectural Design

Received: 06.12.2019. / Accepted: 20.12.2019.

Published online: 10.07.2020.

Review paper

<https://doi.org/10.37023/ee.7.1.2>

## 1. INTRODUCTION

Throughout the world, reinforced concrete (RC) frames are common load-bearing systems of multi-storey buildings. In order to form spaces within such buildings, various kinds of infill walls are introduced by the architectural design. Commonly, infill walls contain one or more openings in order to allow communication between the spaces and/or the incursion of light.

During an earthquake event, such aforementioned buildings are considered to have a higher degree of seismic vulnerability (Schwarz et al. 2015). Furthermore, European seismic codes (CEN 2004) regard infill walls as *non-load-bearing elements*. This, however, was a simplification made by code creators, as at the time, there was little to no knowledge about infill-frame interaction. As many researchers found, infill does influence the stiffness, crack and yield patterns, failure modes etc. (Asteris et al. 2013; Di Trapani et al. 2015; Dowrick 2009; Penava et al. 2018). Likewise, openings in terms of their type, size, position and combination have their share influencing the behaviour (Akhoundi et al. 2016; Cetisli 2015; Kakaletsis & Karayannis 2008; Sigmund & Penava 2014; Wang 2017).

Therefore, there is a need to blend architectural practice and engineer's demands. This paper lays out the principles of opening size and position within unreinforced, masonry (URM) infill walls in order to comprehend such a demand.

## 2. CLARIFICATION OF MASONRY INFILL WALL DESCRIPTIONS IN EARTHQUAKE CODE STANDARDS

There are certain differences in description and structural design of infill walls between various seismic codes. A short summarisation of the code's provisions with respect to the masonry infill walls are presented in further sub-sections.

### 2.1. Eurocode 8 (EN 1998-1-1)

European seismic standard, Eurocode 8, i.e. EN 1998-1-1 (CEN 2004), regard a frame or frame equivalent dual concrete systems (DCS) of high ductility (DCH) with interacting non-engineered masonry infills, if it satisfies the following conditions: a) Infill is constructed after the concrete in the frame hardens; b) Masonry infill is in the contact with the surrounding frame (i.e. without special separation joints, gaps, etc.), but without structural

connection to it (through ties, belts, posts or shear connectors); c) They are considered in principle as non-structural elements.

Again, Eurocode 8, i.e. EN 1998-1-1 (CEN 2004), states that infills can be neglected. However, if engineered masonry infills are a part of the seismic resistant structural system, analysis and design should be carried out in accordance with the criteria and rules given in “Rules for simple masonry buildings” for confined masonry.

As a principle, the consequences of irregularity in plan and elevation produced by the infills should be considered in the design. High uncertainties related to the behaviour of the infills should be accounted for. Those are, namely, the variability of their mechanical properties and of their attachment to the surrounding frame, their possible modification during the use of the building, as well as their non-uniform degree of damage suffered during the earthquake itself. Also, designer should account for possible adverse local effects due to the frame-infill interaction (e.g. shear failure of columns under shear forces induced by the diagonal strut action of infills).

Strongly irregular, unsymmetrical or non-uniform arrangements of infills in plan should be avoided (considering the extent of openings and perforations in infill panels). Infill panels with more than one significant opening or perforation (e.g. a door and a window, etc.) should be disregarded in models for analyses.

Furthermore, if there are considerable irregularities in elevation (e.g. drastic reduction of infills in one or more storeys compared to the others); in principle, the seismic action effects in the vertical elements of the respective storeys should be increased. For the frame or DCS belonging to all ductility classes, DCL (low), M (medium) or H (high), except in cases of low seismicity, appropriate measures should be taken to avoid brittle failure and premature disintegration of the infill walls (in particular of masonry panels with openings or of friable materials), as well as the partial or total out-of-plane collapse of slender masonry panels. Particular attention should be addressed to masonry panels with a slenderness ratio (ratio of the smaller of length or height to thickness) of greater than 15.

Examples of measures for the improvement of both in-plane and out-of-plane integrity and behaviour, include: a) light wire meshes well anchored on one face of the wall; b) wall ties fixed to the columns and cast into the bedding planes of the masonry; c) concrete posts and belts across the panels and through the full thickness of the wall. If there are large openings or perforations in any of the infill panels, their edges should be trimmed with belts and posts.

## 2.1. Federal Emergency Management Agency (FEMA)

In comparison with Eurocode 8 provision (CEN 2004), FEMA 356 (ASCE 2000) has a different approach in its requirements. It states that RC frames with masonry infills should be constructed in such a way that the infill and the concrete frame interact when subjected to vertical and lateral loads. The columns act as vertical chords, beam as horizontal ties and the infill as an equivalent diagonal strut. On one hand; FEMA 306 (ATC, 1998) states that, to be effective at resisting in-plane lateral loads, the infill must be in contact with the surrounding frame. On the other hand; FEMA 749 (FEMA P-749 2010) states that ordinary concrete and ordinary masonry bearing wall systems are not permitted in *Seismic Design Categories* D or higher.

## 2.1. National Building Code of Canada (NBC)

National Building Codes of Canada (NRCC 2010) states that masonry infill walls are to be treated as shear walls and should be designed to resist both in-plane and out-of-plane loads along with any vertical loads. The increased stiffness of lateral load-resisting elements that consist of masonry infill shear walls working with the surrounding frame, should be considered when distributing the applied loads to these elements. When diagonal strut is used to model the infill shear wall a truss model can be used to design in-plane behaviour, and arching action model for the out-of-plane behaviour.

The code offers three possible design and construction approaches for infill walls:

1. Participating infill (diagonal strut approach) – when there are no openings or gaps between the masonry infill and the surrounding frame, but the infill is not tied or bonded to the frame, the infill should be modelled as a diagonal strut. Where openings or gaps exist, the designer must show through experimental testing or special investigations that the diagonal strut action can be formed and all other structural requirements for the infill shear walls can be developed.

2. Frame and infill composite action – when the infill shear wall is tied and bonded to the frame to create a composite shear wall, where the infill forms the web and the columns of the frame form the flanges of the shear wall.

3. Isolated infill - it is also possible to design an isolated infill panel, which is separated from the frame structure by a gap created by vertical movement joints along the ends and a horizontal movement joint under the floor above or beam. In that case, masonry infill is a non-load-bearing wall and cannot be treated as a shear wall. Restraints must be provided at the top of the wall to ensure stability for out-of-plane seismic forces.

### 2.3. The New Zealand Standard (NZS)

The New Zealand Standard NZS 4230:2004 (NZSI 2004) states that the infill panels should be designed to resist all actions resulting from in-plane loads and face loads (out-of-plane, i.e. wind or earthquake). Masonry infills should be designed as elastic structures and detailed to ensure that infill and frame act together in full composite action as a shear wall. Structural infill panel reinforcement should be connected to adjacent beams and columns to ensure that composite action. Infill panels with openings should be subject to special study to ensure diagonal bracing action can be obtained, and to investigate the effects of structural modification caused by the openings. Infill panels separated from the structural system are considered to be partitions.

## 3. RESTRICTIONS IMPOSED TO OPENING SIZES AND POSITIONS FROM ARCHITECTURAL AND ENGINEERING CRITERIA

The openings in this section are referred to doors and windows, which positions and sizes are limited by architectural and engineering concepts.

### 3.1. Architectural design concepts

The analysis starts with the definition of window and door given by architectural concept required for a proper living style. Neufert and Neufert (2012) in the same reference, provide a mesh of recommended sizes for windows and doors which are connected with the masonry modulation.

#### 3.1.1. Masonry walls

Perimeter ties (column ties and lintel) are required for the transfer of horizontal forces over all external and transverse walls in buildings with more than two full storeys or more than 18m in length and walls with many or large openings under the floor slab. This rule applies when the sum of the opening area is higher than 60 % of the surface, or is higher than 40 % of the surface length, or these openings have a width larger than 2/3 of the height of the floor.

Table 1 presents the recommended thickness, separation and longitude for load-bearing walls defined by Neufert and Neufert (2012).

**Table 1.** Thickness, separation and longitude of the load-bearing walls

Wall thickness (cm)		Clear wall height (m)	Separation (m)	Longitude
≥ 15.50	< 17.50	≤ 3.25	≤ 4.50	≥ 1/5 of the floor height
≥ 17.50	< 24.00		≤ 6.00	
≥ 24.00	< 30.00	≥ 3.50	≤ 8.00	
≥ 30.00		≤ 5.00 or 12 t		

#### 3.1.2. Window openings

Window in itself, has an essential function apart from just sealing the opening. It controls the level of natural lighting, the supply and extraction of air and the view outside. The size and location of windows in rooms, in addition to the requirements under building regulations and the rules for daylight in interiors are determined above all by architectural considerations. Important factors are: the location in the wall, with internal windows emphasizing the wall depth and external windows allowing the wall to present as a surface; aspect ratio; the ratio of construction thickness to glass area (visible frame, casements and possibly glazing bar widths); and the relationship to other façade elements (which is often neglected when replacing windows). The type of opening determines the functional quality as a ventilation element.

In residential buildings the minimum requirement for structural window apertures in occupied rooms is specified by the building regulations as 1/8 or 1/10 of the plan area of the room. For rooms with dimensions corresponding to those of residential rooms, the minimum height of the glass area is 1.3 m.

Neufert and Neufert (2012) provide guidelines for structural window opening sizes, as described in Figure 1. The *relative length* and *height* in Figure 1 are a multiple of the unit of measure, e.g. for the unit of 125 mm and window opening  $9 \times 11 = (9 \times 125) \times (11 \times 125) = 1125 \times 1375$  mm.

For example, in the case of the living areas which are categorized into shared rooms (living and dining rooms, kitchens) and individual (private) rooms for one or two people (parents' bedroom, children's room, guest room), the individual room can be used with a flexible range of functions. It has an area of approximate 13 m<sup>2</sup>, including movement areas suitable for a wheelchair and possible extension onto an open balcony (Figure 2) and the bedrooms with minimal space of approximate 13 m<sup>2</sup> (as parent's room or twin bedroom) and approximate 8 m<sup>2</sup> (single room).

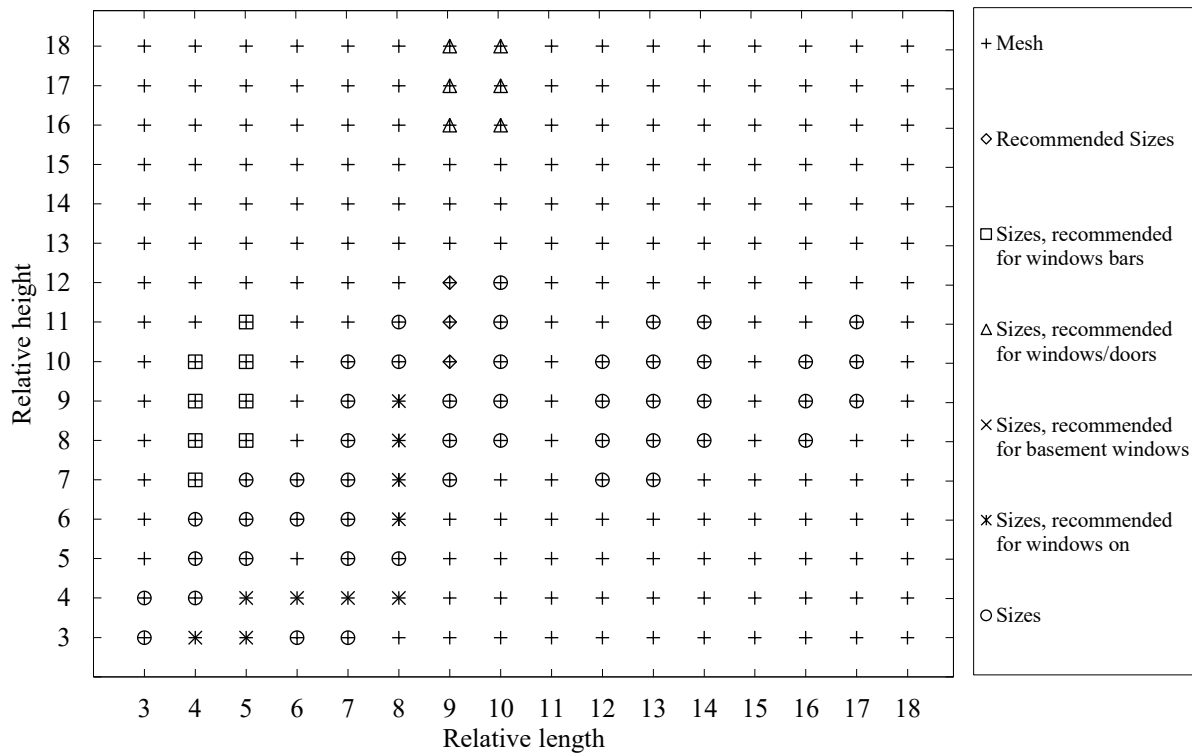

Figure 1. Guideline sizes for structural window openings (Neufert & Neufert 2012)

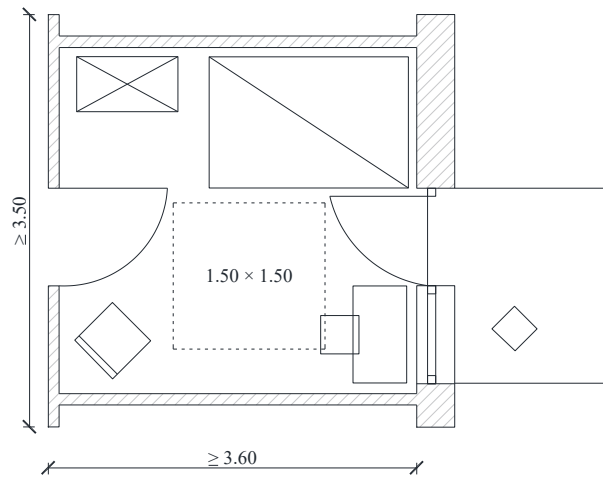

Figure 2. Individual room (Neufert & Neufert 2012)

### 3.1.3. Door openings

Doors must be sensibly arranged as unfavourably distributed or unnecessary doors impair rooms use, or cause difficulties that can lead to the loss of storage places. The width of a door depends on the intended use and the type of room to be accessed. Minimum clear width for walking through is 55 cm, but a minimum dimension for disability-friendly building and marked heights for glass door is 90 cm.

Dimension of wall openings for doors are standard modular dimensions. If, in exceptional cases, different dimensions are required; then their modular dimensions should be whole multiples of 125 mm (100 m according to British Standards (BSI 2015)). A wall opening with 875 mm width and 2000 mm of height (modular dimensions) can be described as: wall opening DIN 18100 – 875 × 2000. In order to determine the door width, the frame detail has to be considered in the calculation of the structural opening, as some variants offer interesting creative possibilities of reducing the clear opening width by more than standard cased doors on the account of the thickness of their construction.

Neufert and Neufert (2012) provide modular wall opening sizes for structural door openings, which are described in the Figure 3.

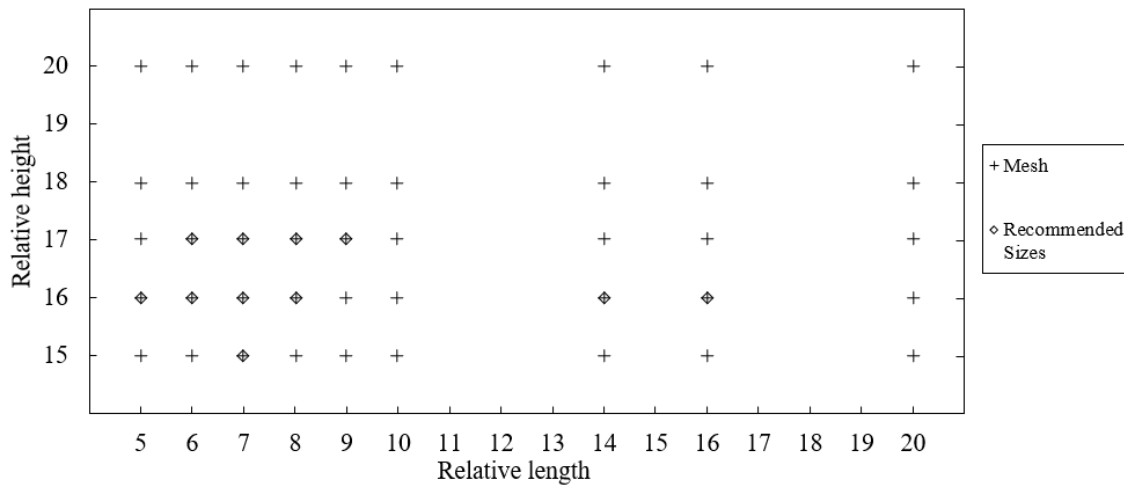

Figure 3. Modular wall openings (Neufert & Neufert 2012)

### 3.2. Engineering design concepts

Eurocode 6 (CEN 2005) and 8 (CEN 2004) provide guidelines to follow the effects of masonry structures but do not define the masonry infilled RC frames. A *stiffening wall* is a wall that is perpendicular to another. Its purpose is to give support against lateral forces or to resist buckling, and by doing so, it provides extra stability to the building. Since there is not a definition of masonry infilled RC frame, the definition of a stiffening wall is used through this paper.

#### 3.2.1. Eurocode 6 (EN 1996)

Eurocode 6 (CEN 2005) provides no rules regarding the openings, however, it has certain recommendations. A recommendation of the walls' minimum length between openings is given by the analysis of structural members subjected to vertical loading and is presented in the **Figure 4**, where the stiffening wall should extend a distance of at least 1/5 of the storey height beyond each opening.

The recommendation defines the effective height of masonry walls rather than the wall openings. For example, walls with openings that have a clear height of more than 1/4 of the clear height of the wall or a clear width of more than 1/4 of the wall length or an area of more than 1/10 of the total area of the wall, should be considered as having a free edge at the opening for the purposes of determining the effective height.

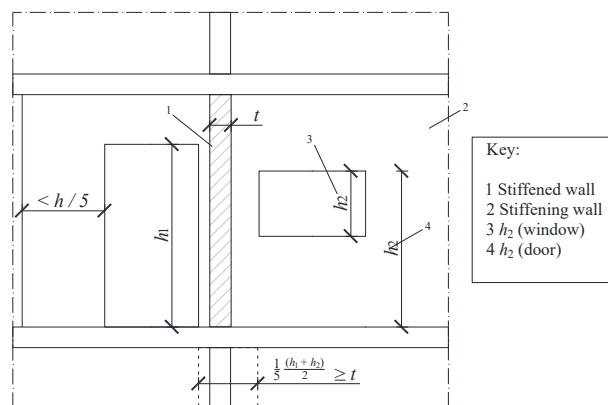

Figure 4. Minimum length of stiffening wall with openings

#### 3.2.2. Eurocode 8 (EN 1998)

Eurocode 8 (CEN 2004) lays out specific rules for masonry buildings. It provides general design criteria and construction rules where shear walls should conform to certain geometric requirements. The ratio of length of the wall ( $l$ ), to the greater clear height ( $h$ ), of the openings adjacent to the wall, may not be less than its minimum value:  $\min(l/h) = 0.4$  for unreinforced masonry (with other type of units other than stone) and 0.3 for confined masonry.

Regarding the additional requirements for confined masonry, vertical confining elements should be placed at both sides of any wall opening with an area of more than 1.5 m<sup>2</sup>. It was shown that in the case of in-plane loading,

confining elements contribute significantly to the overall capacity and the behaviour (Radnić et al. 2012; Penava et al. 2018).

#### 4. RELATIONS BETWEEN ARCHITECTURAL AND ENGINEERING CONCEPTS

Eurocode 6 (CEN 2005) and 8 (CEN 2004) provide engineering guidelines for structural design. The comparison of architectural and engineering concepts can define a competent masonry infilled frame with openings. In hindsight, it would allow definition of not just the aspect ratio parameters regarding the full, partial or non-existing masonry infilled frames; but also, when does the infilled frames act as engineered or non-engineered structure due to shear loads.

The first step was to define the relations between the aspect ratio of each infilled wall regarding the window length. For this case the starting point was set at a height of 2.5 m as recommend by Neufert and Neufert (2012) to 4.5 m. After that, the relation of the aforementioned height to the minimum distance of the wall with openings ( $h/5$ ) was done; then, by selecting each opening length recommendation from Figure 1 resulted in an aspect ratio mesh of opening length which is presented in the Figure 5 and presents the boundaries for the windows.

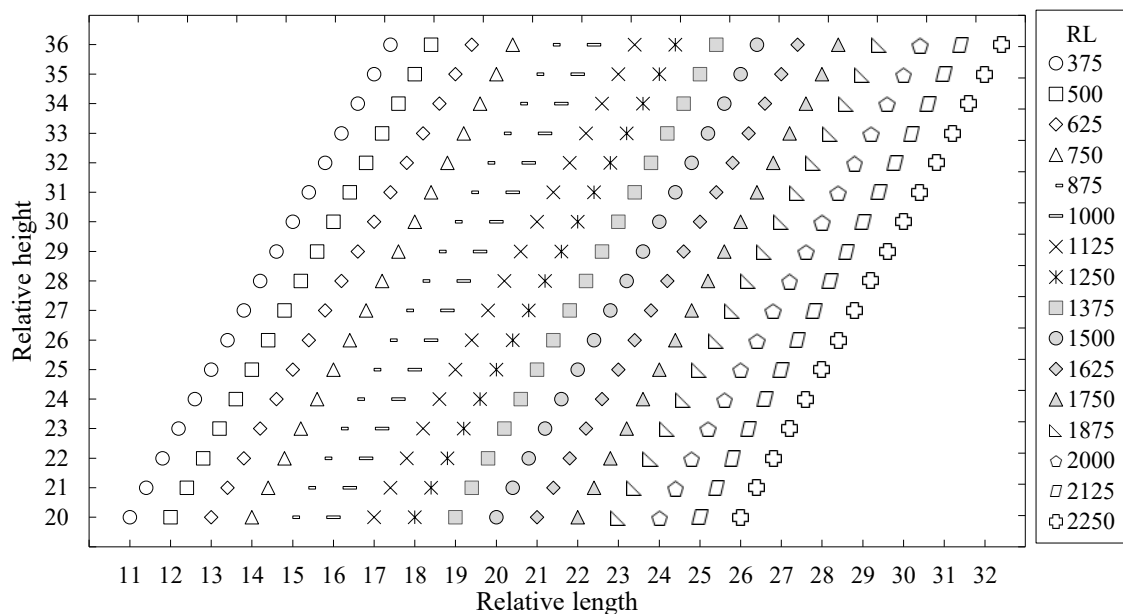

Figure 5. Aspect ratio mesh by window length (RL)

The next step is to create an aspect ratio for doors and then define the boundaries for a full or partial masonry infilled wall with openings.

For the case of window’s aspect ratio, the tendency is to have a wide range, namely, values ranging between 0.17 and 6.55. However, Neufert and Neufert, (2012) recommend that the aspect ratio is limited from the value of 0.4 to 2.35, whilst, most of them range from 0.4 to 1.57.

Similarly, for the value of window’s area, the tendency is also to have rather wide spectrum, ranging from 0.14 to 5.10 m<sup>2</sup>. Again, Neufert and Neufert, (2012) recommend the area of the openings from 0.14 to 3.39 m<sup>2</sup>. Where the upmost range from 0.14 to 2.74. This means that a part of the recommended opening sizes need vertical confining elements (CEN 2004). The area relations within the engineering codes and architectural guides are presented in Figure 6.

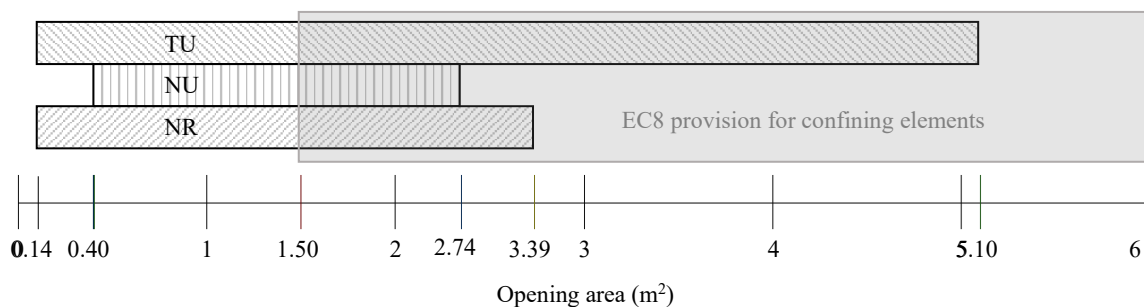

Figure 6. Area of window opening (TU – Typically Used, NR – Neufert Recommendations, NU - Neufert Upmost recommended, EC8 – Eurocode 8)

## 5. CONCLUSIONS

In seismic regions throughout the world, commonly used structural system of multi-storey building are reinforced concrete frames that are usually infilled with some kind of masonry wall. Those masonry walls can contain one or more openings.

In the scientific literature, it is known that both infills and openings affect the overall seismic behaviour of infilled frames. They contribute to overall stiffness, failure modes, capacities, deformation capabilities etc.

Hence, there is a need to unite both architectural and engineering design in terms of opening type, size and placement. Conjointly, this paper reviewed various seismic codes in terms of infilled frame design with the incursion of openings, along with architectural design guidelines. It could be noted that there are wide discrepancies between themselves in regard to the effects of the openings and the incursion of infilled walls in the analysis. Furthermore, from the lack of regulations regarding infill walls, the load-bearing wall, i.e. engineered masonry provisions were consulted.

By combining both the architectural and engineering regulations and recommendations, guidelines and limitations are derived. Those can be used to derive modelling criteria and to define modelling parameter for aspect ratio of walls and openings that works for both architectural and engineering purposes.

## 6. REFERENCES

- Akhoundi F, Vasconcelos G, Lourenco P, Silva L (2016) Out-of-plane response of masonry infilled RC frames : Effect of workmanship and opening. In: Modena, C., F., da P., Valluzzi, M.R. (Eds.), 16th International Brick and Block Masonry Conference. CRC Press/Balkema, Padova, Italy, 1147–1154
- ASCE - American Society of Civil Engineers (2000) FEMA 356 Prestandard and Commentary for the Seismic Rehabilitation of Building
- Asteris PG, Cotsovos DM, Chrysostomou CZ, Mohebkhah A, Al-Chaar, GK (2013) Mathematical micromodeling of infilled frames: state of the art. *Eng. Struct.* 56:1905–1921
- ATC (1998) Evaluation of earthquake damaged concrete and masonry wall buildings: basic procedures manual (FEMA 306). Redwood City, California
- BSI (2015) BS 4787-1:1980 | Internal and external wood doorsets, door leaves and frames. Specification for dimensional requirements
- CEN (2004) Eurocode 8: Design of Structures for Earthquake Resistance - Part 1: General Rules, Seismic Actions and Rules for Buildings (EN 1998-1:2004). European Committee for Standardization, Brussels
- CEN (2005) Eurocode 6: Design of masonry structures - Part 1-1: General rules for reinforced and unreinforced masonry structures (EN 1996-1-1:2005). European Committee for Standardization, Brussels
- Cetisli F (2015) Effect of openings on infilled frame stiffness. *J. Croat. Assoc. Civ. Eng.* 67
- Di Trapani F, Macaluso G, Cavaleri L, Papia M (2015) Masonry infills and RC frames interaction : literature overview and state of the art of macromodeling approach. *Eur. J. Environ. Civ. Eng.* 19
- Dowrick DJ (2009) Earthquake Resistant Design and Risk Reduction, 2nd ed, Wiley Online Library: Books CN - 2009008862. John Wiley & Sons Ltd
- FEMA-P-749 (2010) Earthquake-Resistant Design Concepts: An Introduction to the NEHRP Recommended Seismic Provisions for New Buildings and Other Structures. Washington, DC
- Kakaletsis DJ, Karayannis CG (2008) Influence of masonry strength and openings on infilled R/C frames under cycling loading. *J. Earthq. Eng.* 12, 197–221
- Neufert E, Neufert P (2012) Architects' data, 4th ed. Wiley-Blackwell
- NRCC (2010) National Building Code of Canada. Ottawa
- NZSI (2004) NZS 4230:2004 Design of reinforced concrete masonry structures. Wellington
- Penava D, Sarhosis V, Kožar I, Guljaš I (2018) Contribution of RC columns and masonry wall to the shear resistance of masonry infilled RC frames containing different in size window and door openings. *Eng. Struct.* 172:105–130
- Radnić J, Harapin J, Smilović M (2012) Influence of vertical tie columns on bearing capacity of masonry walls. *J. Croat. Assoc. Civ. Eng.* 64:271–284
- Schwarz J, Abrahamczyk L, Leipold M, Wenk T (2015) Vulnerability assessment and damage description for R.C. frame structures following the EMS-98 principles. *Bull. Earthq. Eng.* 13:1141–1159
- Sigmund V, Penava D (2014) Influence of openings, with and without confinement, on cyclic response of infilled R-C frames - An experimental study. *J. Earthq. Eng.* 18
- Wang C (2017) Experimental investigation on the out-of-plane behaviour of concrete masonry infilled frames. Dalhousie University

# POSSIBILITY OF USING LANDSAT SATELLITE RECORDINGS IN VISUALIZATION AND DETECTION OF THERMAL ISLANDS IN THE AREA OF THE CITY VINKOVCI

Ivana Petrinjak<sup>1</sup>, Nikola Kranjčić<sup>1\*</sup>, Milan Rezo<sup>1</sup>, Bojan Đurin<sup>2</sup>

<sup>1</sup> University of Zagreb, Faculty of Geotechnical Engineering, Hallerova aleja 7, 42000 Varaždin, Croatia

<sup>2</sup> University North, Department of Civil Engineering, Jurja Križanića 31b, 42000 Varaždin, Croatia

\*E-mail of corresponding author: nikola.kranjicic@gfv.unizg.hr

**Abstract:** All satellite data is generated as a record of electromagnetic radiation detected on the satellite sensor. The product of collecting information in remote explorations is a digital satellite record consisting of a pixel network representing the smallest surface that a particular sensor can collect, which is also a spatial resolution of the image. The position of each pixel is determined in the Cartesian coordinate system. To allow the ability to monitor climate change or mitigate the consequences of a natural disaster, the USGS has developed the Earth Explorer tool. USGS (US Geological Institute) provides science on natural hazards endangering life and existence; water, energy, minerals and other natural resources we rely on. This analysis will highlight the ability to use and monitor satellite imagery using the Earth Explorer browser. All satellite images are processed in QGIS. The spatial resolution of the satellite index (NDVI) as a quantitative measure of the state of the vegetation cover was tested on Landsat 8 images in the area of the city of Vinkovci. Highlighted natural disasters are thermal islands, and damage to the forest cover.

**Keywords:** USGS Earth Explorer, Landsat 8, natural disasters, floods, thermal islands.

---

Received: 24.09.2019. / Accepted: 16.01.2020.

Published online: 10.07.2020.

---

Original scientific paper

<https://doi.org/10.37023/ee.7.1.3>

## 1. INTRODUCTION

Remote Sensing is the process of detecting and monitoring the physical and solid surface area by measuring reflected and emitted radiation at a distance from the targeted areas. Special cameras capture images of Earth from a distance that help researchers "feel" things around Earth. It excludes all activities from recordings, procedures, analyzes, interpretations, and obtains data from data collected through these studies (Lapaine & Francula 2015)

Data is obtained from long distance (from several hundred to several thousand kilometres) instruments placed in aircraft or spacecraft. The first aerial photography of the Earth was made in the mid-19th century. In 1858, the Balloon Tournachon made the first recordings to analyze the metropolitan area of Paris, and in 1862, the recordings used in the American Civil War. Massive application of aerial imagery and photointerpretation began in the First and continued in the Second World War. The revolution in remote sensing is the beginning of space photography. The first capture of Earth from space was done in 1959 by the US Explorer, Explorer 6. There are several recording procedures, which are sorted by recording (full size or results), equipment (photographic or electronic), transmission and processes (analogue or digital), number of channels in the spectrum (single or multi-channel), recording view (plane or stereoscopic), use of natural radiation or broadcast with the aircraft (passive or active), usage (for geodetic, cartographic, agrotechnical, meteorological, traffic, military and other needs).

Some specific usage of remote sensing images:

- large forest fires can be mapped from space, which enables monitoring of larger area,
- cloud monitoring to predict the weather or view of the volcano's evacuation and help track storms.
- monitoring the growth of the city and changes in farmland or forests over several years or even de-seeding,
- Ocean Bottom Mapping - Detecting and mapping rough ocean bottom topographies (e.g., huge mountain ranges, deep-sided canyons and "magnetic strip" at the bottom of the ocean).

The beginning of collection usable and more widely available satellite information with applications to various segments of human activity is closely linked to the Landsat mission, which has operated since 1972 to the present. The Landsat program, which established a collaboration between the United States Space Agency (NASA) and the US Geo-logical Survey (USGS), consist of a series of satellite missions (Landsat 1 - Landsat 8). They have been continuously upgraded to this day, and today they are one of the most significant sources of global retrospective data (Gutman & Masek 2012). The use of satellite Landsat imagery has been particularly increased in last few years since the archives of the recordings are made public on the USGS portal. It is



important to familiarize society with readily available information so that different scientific fields can progress more easily. The most used satellite imagery sources are USGS Earth Explorer, Landviewer, Copernicus Open Access Hub, Sentinel Hub, Nasa Earthdata Search, Remote Pixel, INPE Image Catalogue ([Top free satellite imagery sources in 2019](#)).

This paper seeks to emphasize the issue of natural disasters, followed largely by environmental pollution sources. Furthermore, besides population growth, environmental pollution is also significantly influenced by human activities, whose primary role is meeting the needs of a part of the population, with the most significant impact on the natural environment in the form of greenhouse gases, environmental degradation, increasing wastewater, etc. Therefore, introducing the monitoring of satellite images in order to protect natural resources and enable further growth and development of the planet Earth. Recent advances in remote sensing and technology applications have made it possible to use remote sensing satellite imagery to assess the vulnerability of urban areas to natural disasters such as earthquakes. QuickBird, a high-resolution commercial satellite with a maximum spatial resolution of 0.6 m, successfully launched on October 18, 2001. It acquires optical images of urban areas and enables the identification and assessment of critical areas at which objects are most at risk (developing threat assessments, plans protection). The area of the Republic of Croatia, as part of the Mediterranean-Transasian belt, is characterized by a pronounced seismic activity and in the future, this type of monitoring could be applied in the construction of resilient buildings

## 2. LANDSAT MISSION

Since 1972, Landsat satellites have provided continuous spatial data on Earth's terrestrial surface in order to improve scientific research in order to understand our rapidly changing planet. First Landsat satellites generated a vast amount of new data that improved the mapping of remote areas and geological features along with digital vegetation analysis. Landsat's spatial and spectral resolutions have increased its use for broader societal benefits such as global crop forecasting, forest monitoring, water use, carbon estimates, and as a basis for developing a Google map. Landsat's long-term data record is important resource for monitoring land cover change and land use over a period of more than four decades. A free and open Land-Hour data policy, published in 2008, launched a global-scale survey. Developing analytical and computational capabilities allows solving a complex worldwide problem. Landsat offers real-time monitoring capabilities to help further understand the changing planet Earth. Thus, a unique historical archive was created that stands out for its number of details, quality and the spatiotemporal segment covered. This database continuously provides insight into the visual and scientific features of our planet. The Landsat recording archive is often cited as one of the greatest treasures of humanity, an achievement that brings great benefit to all segments of society ([Butcher et al. 2019](#)). **Table 1** shows the characteristics of the Landsat missions, where R - Red, G - Green, B - Blue, NIR – Near Infrared, SWIR – Short Wave Infrared, TIR – Thermal Infrared, MID - Mid-Infrared, MS - lower spatial resolution - multispectral, PAN - higher spatial resolution - panchromatic. Early Landsat recordings revealed many errors in modern nautical charts. For example, researchers have seen that reefs, coasts, and islands have been misplaced or omitted entirely in the Chagos Islands (**Figure 1**; left). Landsat provided information to warn boaters in the region until the revised chart (**Figure 1**; middle) included the newly discovered Colvocoresses coral reef (fully submerged "Indian Ocean atoll") and the adjusted position of the ring coral reef, Speakers bank. Landsat dated April 2, 2018 (**Figure 1**; right) shows the current locations of the Colvocoresses, Speakers Bank and Blenheim reefs.



**Figure 1.** Nautical map and new coral reef in Indian ocean ([Butcher et al. 2019](#))

**Table 1.** Characteristics of Landsat missions (Vela et al. 2017)

Parameters	Landsat 1-3 MSS	Landsat 4-5 TM	Landsat 7 ETM+	Landsat 8 OLI/TIRS
Mission duration	1972 – 1978 1975 – 1983 1978 - 1983	1982 – 1993 1984 - 2013	1999 -	2013 -
Orbit height (km)	915	705	705	705
Spectral channels	R, G, 2 NIR	R, G, B, 2 NIR, MIR, TIR	R, G, B, 2 NIR, TIR, MID, PAN	Coastal, R, G, B, NIR, SWIR-1, SWIR-2, TIR-1, TIR-2, PAN
Spectral resolution (m)	80 MS	30 MS 120 TIR	15 PAN 30 MS 60 TIR	15 PAN 30 MS 100 TIR
Time resolution (in days)	18	16	16	16
Coverage area	185 km x 185 km			

## 2.1. From analogue to digital

First Landsat satellites (1-3) had a Vidicon return beam (RBV) based on proven television technology and the newly developed multispectral scanner (MSS). MSS was the first space instrument to digitally encode Earth data, to obtain orbital calibration data, and to measure data across multiple spectral channels with sufficient geometric fidelity to allow meaningful comparisons between these channels. Although images can be processed from MSS digital data to perform qualitative analysis such as aerial photographs, the potential for quantitative analysis of satellite data - that is, quantitative remote sensing - has been revolutionary. MSS has quickly proven itself in applications such as vegetation types classification and encouraged the adoption of digital satellite data for Earth observation, leading to the development of more advanced multispectral instruments (Butcher et al. 2019).

This process of digital image processing and statistical data analysis redefined modern passive remote sensing from space. The technical characteristics for a new generation of multispectral scanner instruments have been defined based on application - especially agricultural and geological surveys for the new requirements of Thematic Mapper (TM). The TM instrument could be much more sophisticated, with a resolution of 30 m, seven spectral bands and continued on-board calibration. Optimally, the next mission would include two coverage satellites lasting eight days. Landsat 4 and 5 were launched in 1982 and 1984 respectively. With each new generation of sensors, resulted in the need of the Landsat community users for improved spatial and radiometric resolution, spectral and temporal coverage, geolocation, and calibration. Landsat 7 was launched in 1999 with an enhanced Thematic Plus (ETM +) map that added a panchromatic band (band) for increased spatial resolution and increased thermal resolution from 120 m to 60 m. Landsat 8 was launched for shooting about 750 scenes a day, an increase of about 450 scenes a day on Landsat 7 Earth observation, leading to the development of more advanced multispectral instruments (Butcher et al. 2019).

## 2.2. Landsat 8 data

In collaboration with NASA (National Aeronautics and Space Administration), US Department of the Interior, USGS (United States Geological Survey), Orbital Science Corporation and Ball Aerospace & Technologies, and NASA's Goddard Centre for space flight, on 11th February 2013 successfully launched the Landsat 8 satellite at Vandenberg Air Force Base. The original name of the mission (satellite) was LDCM (Landsat Data Continuity Mission), which was changed to Landsat 8 after NASA conducted its satellite testing and verification on May 30, 2013 and hand over operations management to the USGS. The orbit of Landsat 8 is defined in relation to the Worldwide Reference System<sup>5</sup> (WRS-2), synchronized with the Sun and is at an altitude of 7056 km. The inclination of the orbit is 98.2 °. The satellite traverses Earth in 98.9 minutes, and the time of crossing the equator is 10:00 UTC +/- 15 minutes. These orbit characteristics allow the Landsat 8 satellite to cover the entire globe (except for smaller polar regions) every 16 days (EROS 2013). The Landsat 8 satellite (Figure 2) has two sensors for collecting data, for capturing satellite images. The first sensor is the OLI (Operational Land Imager), it has 9 spectral channels, comprising the visible, Near Infrared (NIR) and short wavelength infrared (SWIR) part of the spectrum. One of these nine channels is panchromatic. The second sensor is TIRS and has 2 spectral channels that comprise the Long Wavelength Infrared (LWIR). Table 2 shows the characteristics of the sensors listed.



Figure 2. Landsat 8 satellite in orbit (Francica 2013)

Table 2. Characteristics of OLI & TIRS sensors (EROS 2013)

Sensor	Channel [number]	Wavelength [ $\mu$ ]	Spatial resolution [m]	Description	Channel name
OLI	1	0,43 – 0,45	30	visible	coastal blue
	2	0,45 – 0,51	30	visible	blue
	3	0,53 – 0,59	30	visible	green
	4	0,64 – 0,67	30	visible	red
	5	0,85 – 0,88	30	NIR	near infrared
	6	1,57 – 1,65	30	SWIR	short wavelength infrared - 1
	7	2,11 – 2,29	30	SWIR	short wavelength infrared - 2
	8	0,50 – 0,68	15	panchromatic	panchromatic
	9	1,36 – 1,38	30	Cirrus	Cirrus
TIRS	10	10,60 – 11,19	100	LWIR	long wavelength infrared - 1
	11	11,50 – 12,51	100	LWIR	long wavelength infrared - 2

### 3. MATERIALS AND METHODS

#### 3.1. Research area

The survey was conducted in the Vinkovci area (Figure 3), based on the 2018 Landsat 8 (30 m) satellite imagery. The town of Vinkovci is in the northeast of Croatia between the rivers Danube and Sava, on the river Bosut. They are one from five cities in Vukovarsko-Srijemska County.

The area of the town includes two settlements: Vinkovci and Mirkovce. It is surrounded by seven municipalities: Jarmina, Markušica, Nuštar, Stari Jankovci, Privlaka, Andrijaševci and Ivankovo. It is located at 78-125 m above sea level and the total area of the city is 102805 ha. The surroundings of the countryside are rich in fertile soil. The city is located in an important traffic-geographical area through which international traffic routes pass. Due to its geographic location, it is characterized by a mild continental climate with moderate rainfall throughout the year. Summers are sunny and hot and winters cold with snow. In June 2014, the City of Vinkovci signed a contract with the Institute for Tourism of Zagreb to develop a Master Plan for Tourism Development of the City of Vinkovci. The plan itself will be followed by the redevelopment of cities, the improvement of tourism, the opening of new recreational areas, parks, etc (Boranić Živoder et al. 2015). Decision-makers with insight into the research area of the "Thermal Islands" by using existing technology can see what the temperatures are like in individual cities, in which way the city's construction will be increased, thereby reducing green spaces. Croatian cities have not yet made a major step forward in this regard. Four major cities in Croatia - Zagreb, Rijeka, Osijek and Split - have no empirical research on thermal islands in their urban centres, neither on the relationship between

mortality and high temperatures. Timely responses can ensure the preservation of existing green spaces and encourage the creation of "Green Networks", which directly affects the improvement of the quality of life of citizens.

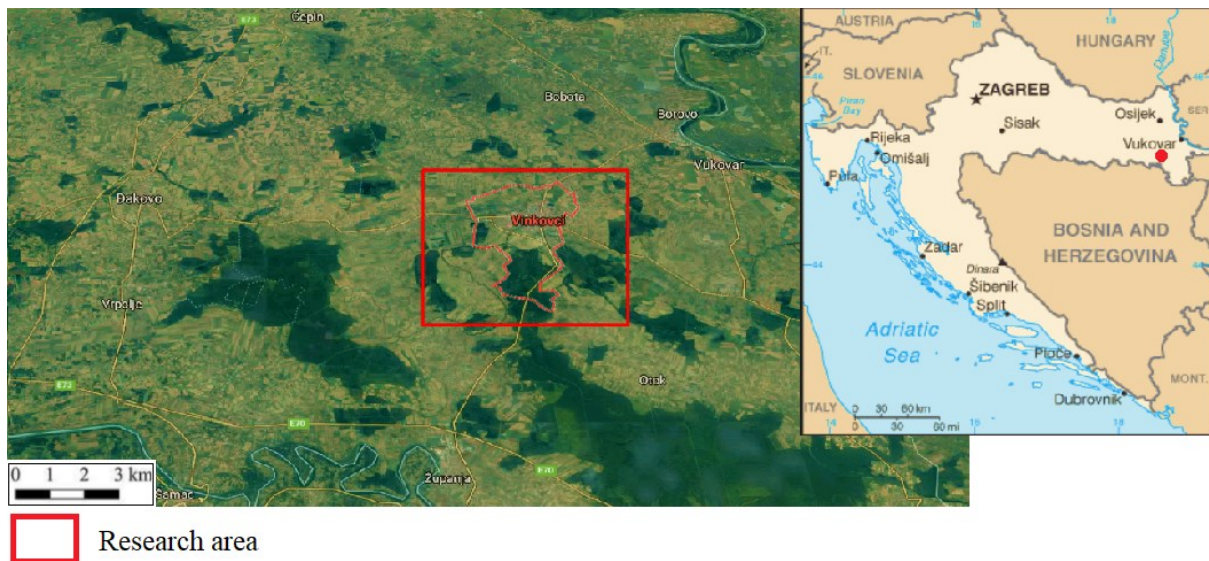

Figure 3. Research area - city Vinkovci

### 3.2. Thermal island

According to the 2018 meteorological records, we can conclude that winter is late and over, and summer is hot and short. In **Table 3** and **Table 4** the temperatures for March and August can be seen. **Table 4** shows the temperatures that in the summer have the greatest impact on the cities where the "heat island" occurs. The thermal island is an area of significantly higher air temperature in relation to the environment, which occurs primarily in cities (**Figure 4**). As heat islands contribute to the greenhouse gas effect, there is also an impact on global warming, leading to global climate change. This ends in one circular cycle ([Agency 2008](#)).

Table 3 Temperature for March 2018 ([AccuWeather 2019](#))

Date	THU 01.03.	FRI 02.03.	SAT 03.03.
Recorded temperature [°C]	-6°/-19°	-1°/-7°	-1°/-3°
Average temperature [°C]	8°/-1°	9°/-1	°9°/-1°

Table 4 Temperature for August 2018 ([AccuWeather 2019](#))

Date	SUN 08.12	MON 08.13	TUE 08.14	WED 08.15	THU 08.16	FRI 08.17	SAT 08.18
Recorded temperature [°C]	30°/17°	33°/17°	33°/18°	29°/16°	29°/15°	32°/15°	33°/17°
Average temperature [°C]	28°/15°	28°/15°	28°/15°	28°/14°	28°/14°	28°/14°	28°/14°

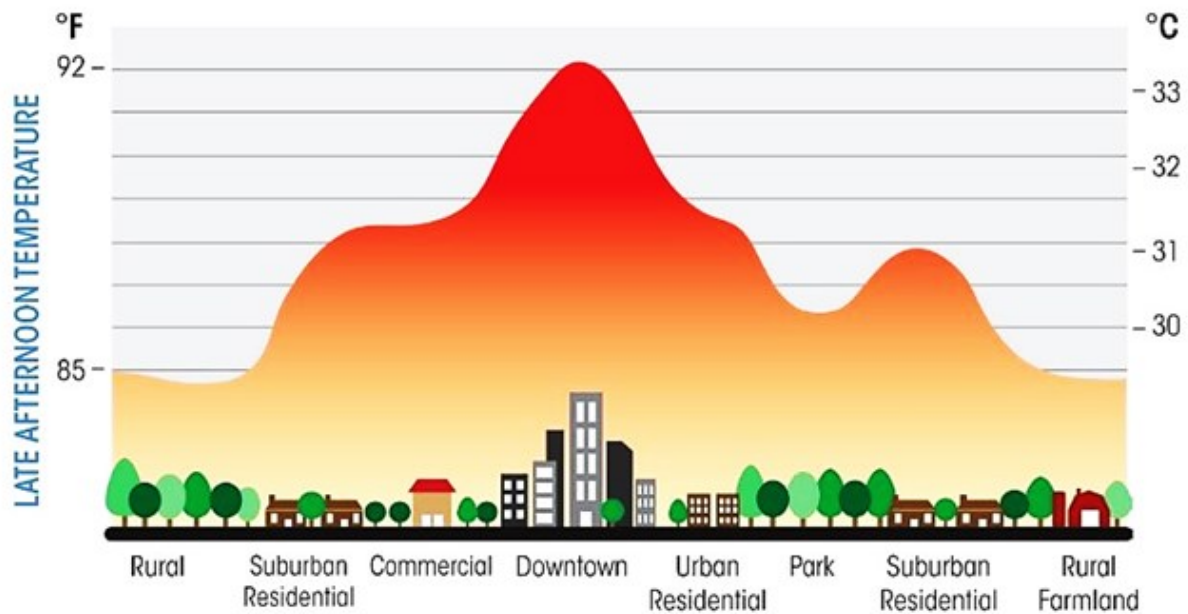

Figure 4. City thermal island profile (measured late afternoon temperature) (SkySpace 2019)

Thermal inland reduces the appearance of weak tornadoes and prolongs the cultivation of plants, but most impacts are negative:

- Increased electricity consumption
- Increased emission of greenhouse gasses
- Impact on human health
- Impact on water quality

The temperature difference in colder seasons can be as high as 10 °C. It is caused by the higher density of residential buildings, the release of heat by the consumption of fossil fuels, traffic and the reduction of natural ventilation. Nowadays on Earth, every city is accompanied by the appearance of heat islands, but the extent of extreme heat de-pends on several factors such as climatic conditions, prevailing winds, type of terrain, type of construction, size of the city. The larger the city, the wider the thermal island. Large cities, such as Paris, London, or Tokyo, have several degrees higher temperatures than the surrounding area, with a tendency to increase as cities expand.

The problem occurs with building materials that do not have a good reflection ability, i.e. they absorb more energy from the Sun, and thus it retains and heats the surface. The increase in temperature is also affected by the height of the buildings and layout, and is usually such that the large amount of heat absorbed during the day is retained and the surfaces are cooled more slowly at night. Another effect in buildings is the blocking of wind, which also prevents cooling, i.e. the reduction of temperatures on building surfaces. Croatian cities have not yet made a major step forward in this regard. According to the surveys con-ducted so far in the Republic of Croatia, none of the surveys concerned thermal islands, i.e. the administrations in Zagreb, Rijeka, Osijek and Split do not have any recorded data on high temperatures in their urban centres. The City of Rijeka recognized this problem and envisaged the erection of a Delta park in the city centre by the Master Urban Plan, which will reduce the effect of the thermal island in the centre and at the same time provide citizens with shelter during the summer heat. In order to calculate the surface temperature, it is necessary to reclassify the (emissivity) classification. The value specified in **Table 5** is entered under the ID for each class assigned during the classification. Also, calculating the sur-face temperature, the **expression 1**.

Table 5. Emissivity values for specific land use

Land use	Emissivity
Water	0.98
Build-up	0.94
Vegetation	0.98
Arable land	0.93

The surface temperature values for a given area are calculated by the following expression:

$$T = T_b / [1 + (\lambda * T_b / c_2) * \ln(e)] \quad (1)$$

where:

$T_b$  = At-Satellite Brightness Temperature

$\lambda$  = wavelength

$c_2 = h*c/s = 1.4388*10^{-2} c_2 = h*c/s = 1.4388*10^{-2} \text{ m K} = 14388 \text{ } \mu\text{m K}$

$h$  = Planck's constant =  $6.626*10^{-34} \text{ J s}$

$s$  = Boltzmann constant =  $1.38*10^{-23} \text{ J/K}$

$c$  = speed of light =  $2.998*10^8 \text{ m/s}$

The emission wavelengths for the Landsat class are listed in **Table 6**.

**Table 6.** The emission wavelength for the Landsat class

Satellite	Class
Landsat 4;5;7	6
Landsat 8	10
Landsat 8	11

### 3.3. Normalized Difference Vegetation Index - NDVI

In order to determine the density of green areas on a certain surface on the Earth, it is necessary to observe the different wavelengths of visible and near-infrared solar radiation reflected from plants. When sunlight reaches plants, the pigments in the leaves (chlorophylls) absorb visible light (0.4 to 0.7  $\mu\text{m}$ ) for use in photosynthesis. The structure of the leaf cells reflects near infrared light (0.7 to 1.1  $\mu\text{m}$ ). The more leaves a plant possesses, the greater the influence on wavelengths of light (**Figure 5**) ([Normalized Difference Vegetation Index \(NDVI\) 2000](#)). Therefore, vegetation in the visible spectrum looks completely different than in the near infrared spectrum. Relative amounts of vegetation are determined on the basis of near-infrared and red wavelengths.

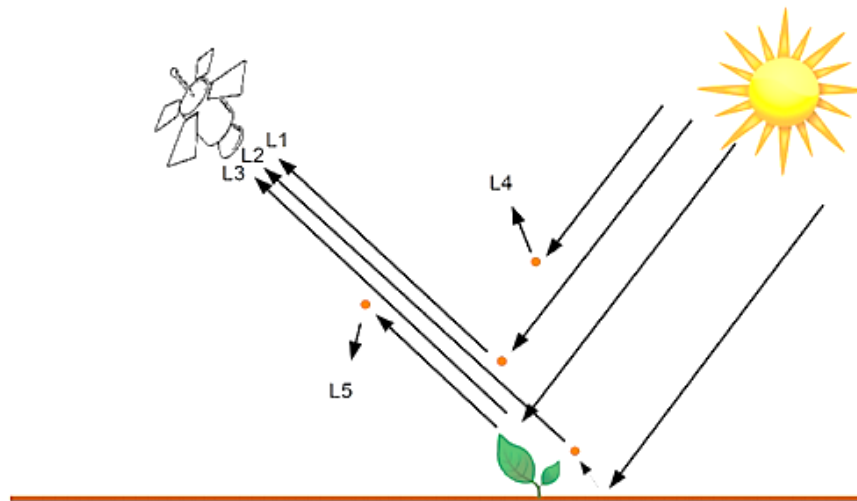

**Figure 5.** Solar radiation reflection (L1 - atmospheric radiation, L2 - reflected radiation, L3 - ambient radiation, L4; L5 - backscattered radiation) ([Rumora et al. 2016](#))

NDVI's biophysical interpretation is a piece of absorbed photosynthetic radiation activity absorbed from the surface (soil). NDVI is affected by a large number of attributes, such as atmospheric conditions, recording scale, vegetation moisture, soil moisture, total vegetation cover, differences in land type, etc. NDVI has a reduced sensitivity to changes in vegetation volume, i.e. with increasing green vegetation change in NDVIs are decreasing more and more. For this reason, at high NDVI values, a small change in NDVI may signify a major change in vegetation. NDVI values (range from - 1 to + 1):

- (0.1 or less – Areas covered with rocks, sand or snow
- (0.2 – 0.5) – Rare vegetation such as shrubs or lawns
- (0.6 – 0.9) – Dense vegetation that can be found in temperate and tropical forests or crops at peak growth ([Huete & Jackson 1987](#))

NDVI can be calculated by **Expression 2**:

$$\text{NDVI} = (\text{NIR} - \text{RED}) / (\text{NIR} + \text{RED}) \quad (2)$$

where:

NIR – near infrared channel,

RED – red channel

## 4. RESULTS

### 4.1. Classification

Classification can be described as division or separation. Classification is conducted according to specific principles or criteria depending on the subject and purpose (e.g. alphabetical order, chronological, etc.). In QGIS, the classification of satellite images is used to obtain (extract) thematic information from satellite images in a semi-automatic or automatic manner. There are various procedures used in the classification process. The basic classification is classified into supervised and unsupervised. Only supervised classification was used in this paper. The implementation of supervised classification requires significantly greater interpreter influence as well as prior knowledge of the study area (field experience, data from other sources, etc.). At the beginning of this process, it is necessary to identify the samples and define the number of classes. Then, the interpreter should select representative samples (pixels) for each class (Oluić 2001). **Figure 6** shows research area in true colour composition, while **Figure 7** shows classification of Vinkovci area.

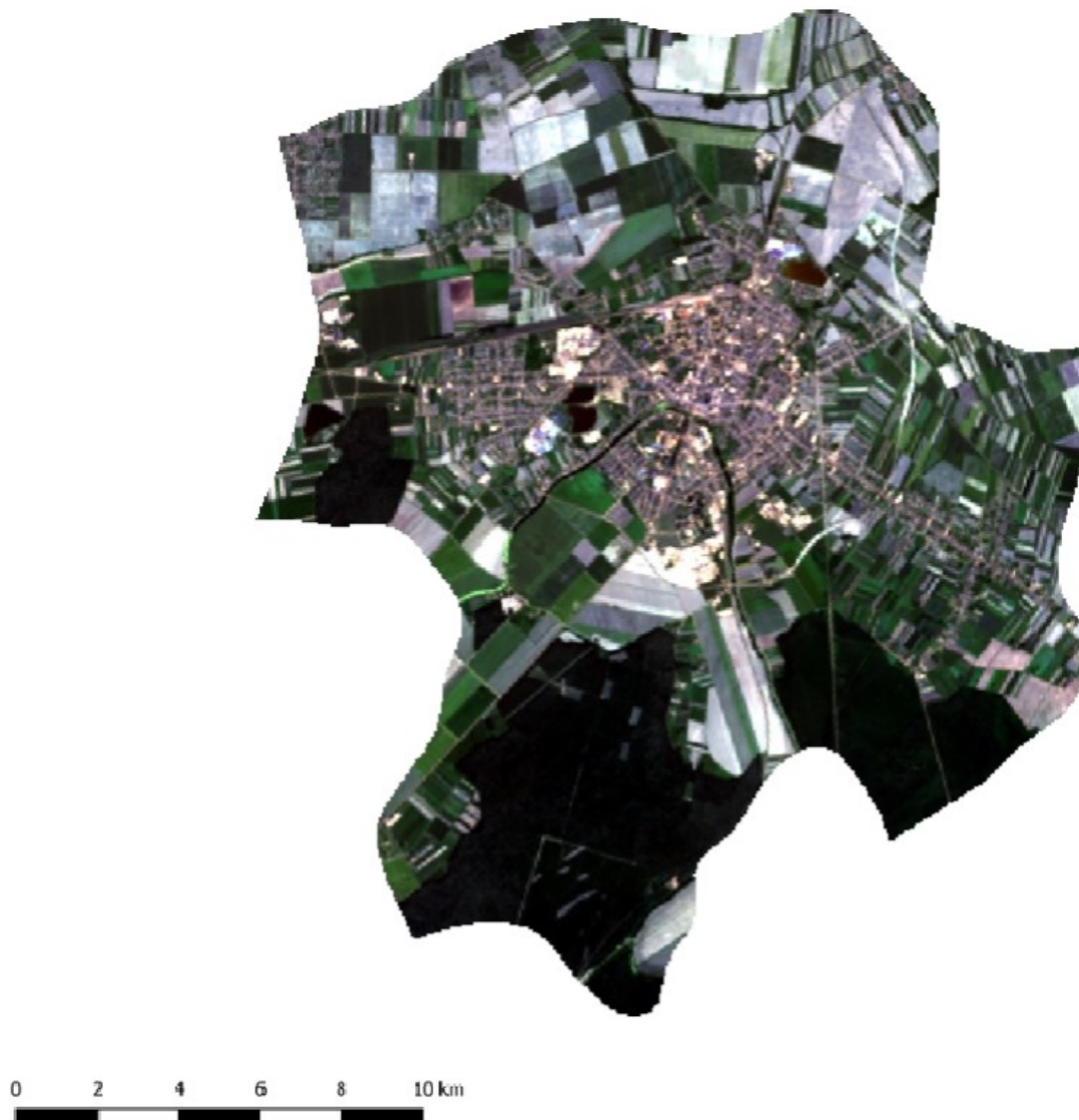

**Figure 6.** True colour composition view of Vinkovci

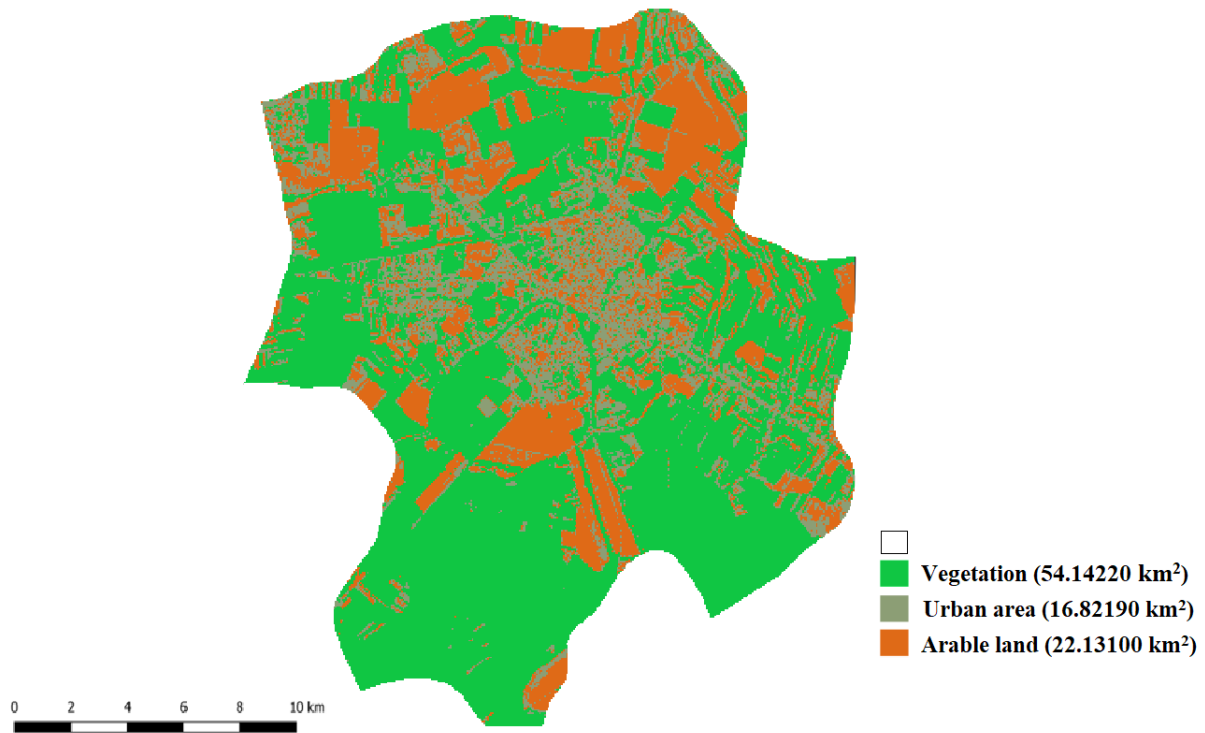

Figure 7. Classification of Vinkovci city area

After the classification of satellite images, the classes are shown polygonal and quantitatively expressed in surface area. In **Figure 7**, which shows the area of the municipality of Vinkovci, the classes are indicated: vegetation (54.14220 km<sup>2</sup>), urban area (16.82190 km<sup>2</sup>), arable land (22.13100 km<sup>2</sup>). **Figure 8** shows the result of the NDVI vegetation index for the cultivated area of the municipalities of Vinkovci for the August. A green colour was used to graphically represent the NDVI analysis. Everything in the grid marked in green indicate that the pixel value is greater than zero (vegetation display). White shows negative values on the grid (low vegetation area or none). According to the colour gradient, it is concluded that the darkest colour indicates the thickest area and the lightest green or white colour less frequently the vegetation area.

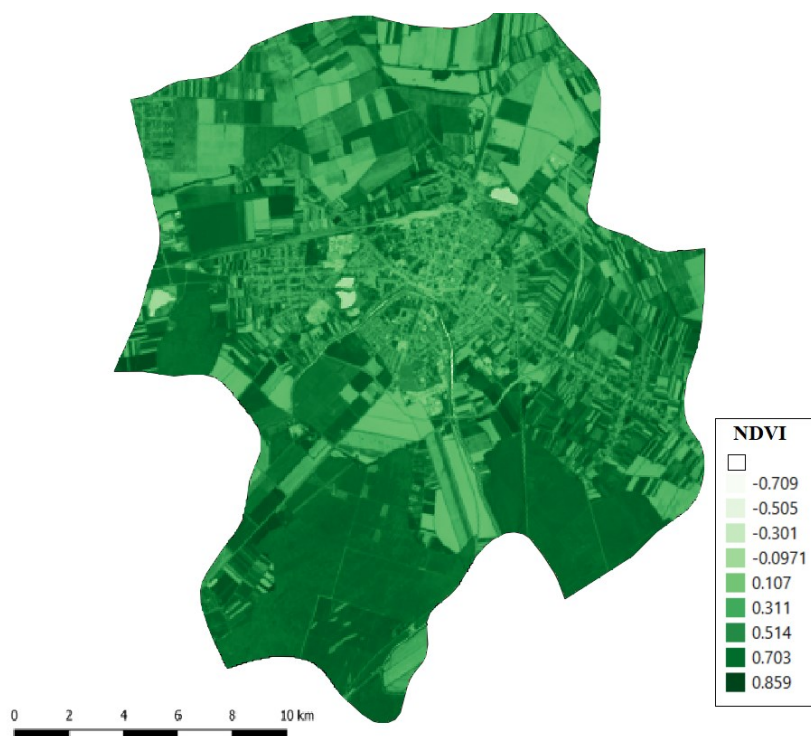
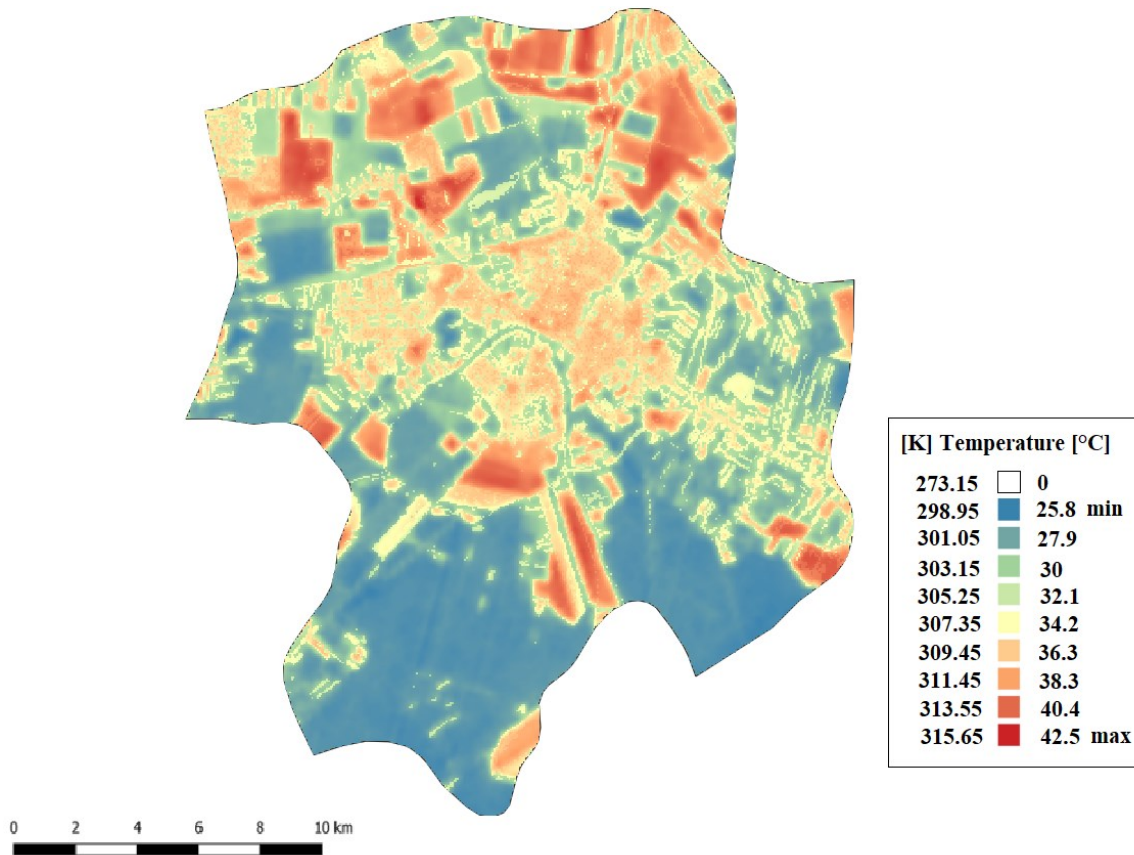

Figure 8. NDVI value for August 2018



**Figure 9** shows the result of determining the surface temperature. The colour spectrum was used to represent the temperature. All shown in red indicates the maximum temperature. Blue indicates the lowest temperature, while other colours indicate the temperature range between min and max. The maximum recorded temperature for August 14 is 42.5 °C and the minimum recorded temperature is 25.8 °C. With good quality satellite imagery, the temperature can be seen rising closer to the city centre. As we approach the forest, that is, vegetation, we see a significant drop in temperature; the difference is 16.7 °C.



**Figure 9.** Temperature values in city Vinkovci

## 5. CONCLUSION

With the help of remote sensing techniques, a spatial analysis is carried out, in which the classes of the area of the town of Vinkovci are detected, analysed and interpreted. With this analysis, the simple principle of classification of vegetation areas, primarily green areas, using the NDVI vegetation index and medium-resolution recordings is present-ed. A simple principle, because indexing is a combination of simple arithmetic operations and the necessary channels. Vegetation indices play a significant role in monitoring and detecting vegetation changes in terms of quantity or quality. Their biggest advantage is that they have a low sensitivity to the instability of the correction for the atmosphere and variations in the angle of observation of the satellite. It is important to emphasize that vegetation indices can monitor the disappearance of forest areas (need for afforestation) or agricultural crops.

Emphasis is also placed on elevated temperatures occurring in the city, i.e. in populated areas. With the help of QGIS software, we can very easily calculate the temperature state on a given surface. The physiological sense of the environment rests on the temperature and humidity of the air, the flow of air, the radiation of objects, the admixtures in the air, when the heat islands appear, they merge and cause pressures on human health. The temperature is measured in the shade of a meteorological house and when the thermometer shows 35 degrees, the temperature in the street can rise to 40 degrees, which in addition to other negative effects can have a significant impact on human health. Some strategies for reducing the "heat island" effect that can be applied in cities or heavily populated areas are increasing green spaces, building green parking lots, building green roofs, building cold / reflective roofs, building cold side-walks, educating about the effect of thermal effects the island.

Satellite imagery is the most widespread way of collecting data on large areas today. There is great potential for ap-plication in forestry, which is the basis for the European Union's Global Observation Program, Copernicus. Of particular importance for exploring innovative remote sensing applications is the range of recent Sentinel satellite missions and the availability of imagery for use by the wider scientific community. At present, there is a

very strong EU initiative aimed at examining different ways of applying and commercializing satellite information, primarily collected from the Sentinel, in different land-based economic sectors (forestry, agriculture, nature protection, water management, etc.). Free satellite imagery can be downloaded with a large amount of new data. The processing of the data is one of the basic prerequisites for obtaining quality results. In the future, interdisciplinarity and the collaboration of all professions from different fields will be important. There is still plenty of room for progress in this field of work. It is possible to work in geo-databases where it would be the source of all information e.g. related to a single location (surface, population, seismicity, temperature, hours of sunshine, soil type, etc.). Also, satellite images can be used in comparison with other images (e.g. Sentinel data) and the ability to compare digital and visual interpretations.

## 6. LITERATURE

- Top free satellite imagery sources in 2019 [online], 2019. *Earth observing system*. Available via: <https://eos.com/blog/7-top-free-satellite-imagery-sources-in-2019>. Cited 14 May 2019
- AccuWeather (2019) Monthly temperatures in Vinkovci [online]. *Accuweather*. Available via: <https://www.accuweather.com/hr/hr/vinkovci/116156/month/116156?monyr=3/01/2018>. Cited 20 Apr 2019
- Agency USEP (2008) Urban Heat Island Basics. In: *Reducing Urban Heat Islands: Compendium of Strategies*. Boranić Živoder S, Ivandić N, Čorak S, Marković I (2015: *Master plan razvoja turizma grada Vinkovaca*.
- Butcher, G, Owen, L, and Barnes, C, 2019. Landsat: the Cornerstone of Global Land Imaging. *GIM International*, 44.
- EROS U (2013) *Landsat 8*.
- Francica J (2013) Everything You Need to Know about Landsat 8 [online]. *Directions Magazine*. Available via: <https://www.directionsmag.com/article/1662>. Cited 14 May 2019
- Gutman G, Masek JG (2012) Long-term time series of the Earth's land-surface observations from space. *International Journal of Remote Sensing*, 33 (15), 4700–4719.
- Huete AR, Jackson RD (1987) Suitability of spectral indices for evaluating vegetation characteristics on arid rangelands. *Remote Sensing of Environment*, 23 (2), 213-232.
- Lapaine M, Frančula N (2015) Kartografija i daljinska istraživanja [online]. Available via [http://www.kartografija.hr/old\\_hkd/daljinska.pdf](http://www.kartografija.hr/old_hkd/daljinska.pdf). Cited 19 Apr 2019
- Normalized Difference Vegetation Index (NDVI) [online], 2000. *NASA Earth observatory*.
- Oluić M (2001) *Snimanje i istraživanje Zemlje iz svemira; Sateliti - Senzori - Primjena*. Hrvatska akademija znanosti i umjetnosti.
- Rumora L, Medved I, Pilaš I, Medak D (2016) Comparison of Vegetation Index Value Based on Digital Number and Top of Atmosphere Reflectance. *Geodetski list*, 70 (93) (1), 15.
- SkySpace (2019) Urban heat island effect [online]. *Sky Space Green Roofs*. Available via: [http://skyspacegreenroofs.com/wp-content/uploads/2016/10/urban\\_heat\\_island\\_effect2.jpg](http://skyspacegreenroofs.com/wp-content/uploads/2016/10/urban_heat_island_effect2.jpg). Cited 20 Apr 2019
- Vela E, Medved I, Miljković V (2017) Geostatistical Analysis of Vegetation Indices in Forest Ecosystem Česma. *Geodetski list*, 71 (94) (1).

# METHODS FOR REDUCING THE ENVIRONMENTAL IMPACT OF ROCK MASS EXCAVATION

Jasmin Jug <sup>1\*</sup>, Kristijan Grabar <sup>2</sup>

<sup>1</sup>University of Zagreb, Faculty of Geotechnical Engineering, Hallerova aleja 7, 42000 Varazdin, Croatia

<sup>2</sup>SPP d.o.o., Trstenjakova 3, 42000 Varazdin, Croatia

\*E-mail of corresponding author: [jasmin.jug@gfv.unizg.hr](mailto:jasmin.jug@gfv.unizg.hr)

**Abstract:** Many engineering projects and interventions have negative effects on the environment. Rock excavation in civil engineering, either in mining or in construction, often is unthinkable without the use of explosive. However, blasting can have extensive adverse environmental impacts, like vibrations, noise, dust and chemical contamination. Therefore, it is better to avoid blasting activities near urban areas, protected animal habitats, sensitive historic buildings, water protection zones, pipelines, etc. While mechanical excavation is often longer lasting and more expensive, in some cases it may adequately replace blasting, where the applicability of mechanical excavation methods greatly dependent on the rock mass characteristics which should excavate. This paper provides practical examples of using existing methods for the assessment of the applicability of excavation technologies. In order to minimize the project impact on the environment, mechanical excavation was applied in some cases. In one case, the blasting could not be avoided, but controlled careful blasting techniques were applied.

**Keywords:** adverse blasting effects, environment, excavation assessment methods, mechanical excavation, careful blasting.

---

Received: 17.01.2020. / Accepted: 03.02.2020.

Published online: 10.07.2020.

---

Original scientific paper

<https://doi.org/10.37023/ee.7.1.4>

## 1. INTRODUCTION

During rock blasting, a chemical reaction takes place, which converts the chemical energy of the explosive into the shock energy and gas energy (Dhekne 2015). Most of the released energy is useful for fragmentation, displacement and movement of broken rock. Wasteful part of energy causes many adverse impacts such as ground vibrations, airblast, fly-rock and dust. Ground vibrations, in other words seismic waves, creates cracks in the surrounding rocks near the blast site and travels at different rates through soil, rocks and water until the energy of the vibration is dissipated. Along their way, blast vibration waves (**Figure 1**) shake humans, animals, plants and any man-made and other natural's installations. The ground vibration parameters, crucial for the safety of constructions, have a significant correlation with charge weight and distance of blasting. The properties of the vibration medium also impact on the value of vibration parameters (Tomberg & Toomik 1999).

The environmental effects air blast or noise and dust vary depending on the size and location of the blast field, but also on atmospheric conditions such as wind and humidity. Dust generated by blasting and suspended into the atmosphere greatly affects air quality. The noise is the result of air-overpressure. Changes in air pressure can physically damage glasses on buildings, trees in the surrounding forests and blasting noises can also impair quality of life for humans and animals (Mesec et al. 2018). The fly-rock or particular rock that flies beyond the blast site, causing damage to property, injuries to people and can lead to the fatalities.

The last factor is most important for the safety of aquifers in the vicinity of blasting area. If commercial explosives are spilt on the ground or left undetonated at a blast site, ammonium and nitrate can reach into ground, surface and groundwater.

An appropriate blast design can help in reducing the environmental impacts of blasting, but in some cases it is better to apply mechanical excavation, which includes the following methods: a) digging when easy/very easy excavation conditions exist, b) ripping for moderate to difficult excavation conditions, and c) breaking when the main purpose of the excavation work is to break rock into smaller fragments by using a hydraulic hammer. Digging is very acceptable in construction and mining, especially hydraulic shovel excavators, which are very versatile machines. Solid rock can be excavated by ripping, but the blasting method is more widely used because ripping is often more expensive. The effects of vibration, noise and dust when using digging and ripping technologies are minimal, and there is no danger to human lives, property and slope stability. The operation of the hydraulic hammer has the adverse effects of vibration and noise, but the level of adverse effects is far below the level of blasting effects.

For the assessment appropriate excavatability method, previous studies proposed different classifications. However, there is no generally accepted method, so many different methods are often combined in researches. In this research, some of the most commonly used are tested on several studied sites.

## 2. METHODS FOR EXCAVATION ASSESSMENT

The methods that are available to predict the rock mass excavatability can be categorised into three classes of methods: an assessment based on seismic velocity, graphical method and grading method. Franklin et al. (1971) presented one of the first graphic methods, based on the correlation between the uniaxial compressive strength of intact rock and the spacing of discontinuities in the rock mass. Weaver (1975) designed the first grading system, taking into account the following features of the rock mass: seismic P-waves velocity, hardness, weathering and spacing, persistence, orientation and separation of discontinuities. However, one of the first developed models for excavation assessment was proposed by Caterpillar Inc. in the late 1950s (Church 1981). This model predicts rock mass ripability primarily based on a seismic velocity of longitudinal P-waves in the rock mass for different rock types, and the assessment procedure was later updated along with the company's latest bulldozers (Caterpillar 2015). There are in the mining profession highly recognized methods for the excavation assessment. For ease of use, three methods were selected.

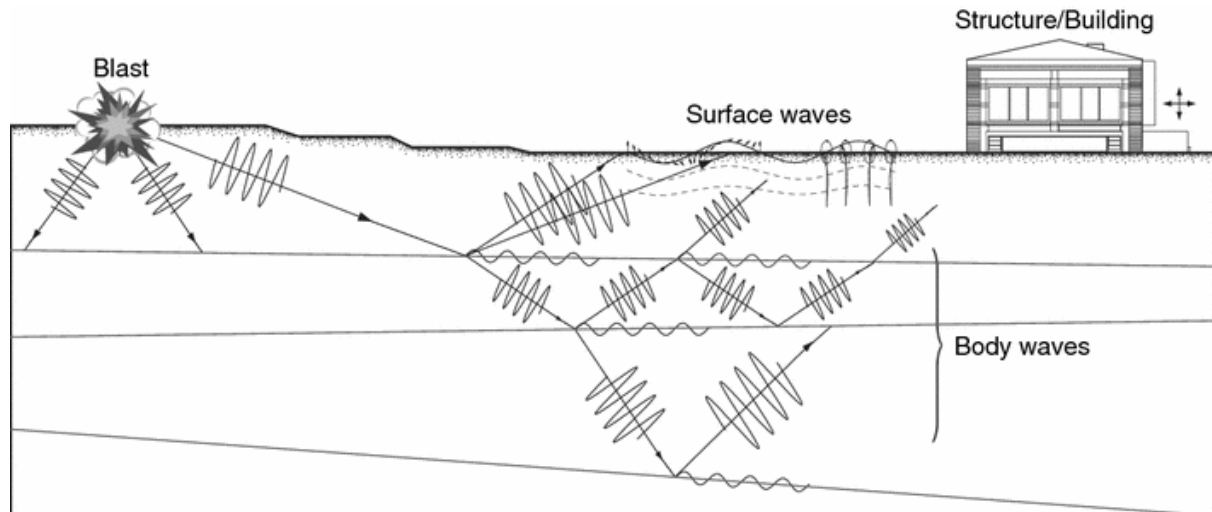

Figure 1. Types of blast vibration waves (Ainalis et al. 2017)

### 2.1. Pettifer & Fokes Method

One of the most recent assessments on rock mass excavatability was proposed by Pettifer & Fookes (1994). The chart for excavation assessing (Figure 2) is based on discontinuity spacing and Point load test index (PLTi). Various problems arise when attempting to describe block size in terms of a single dimension, but this is necessary in order to represent average discontinuity spacing simply. The fracture spacing index ( $I_f$ ), which expresses discontinuity spacing, can be customarily determined from measurements along two orthogonal or randomly orientated scanlines, or along a section of drill core. PLTi is the result of Point Load Test (PLT), also known as the Franklin test (Broch & Franklin 1972).

### 2.2. Hoek & Karzulovic Method

Hoek and Karzulovic (2000) proposed GSI value ranges for different excavation methods. Figure 3 presents a plot of 23 case histories of excavation by digging, ripping and blasting published by Abdullatif & Cruden (1983). Geological Strength Index (GSI), proposed by Hoek et al. (1998), is an easy qualitative tool for the quick assessment of rock mass properties. So, Hoek and Karzulovic concluded that rock mass can be dug by an excavator if the  $GSI < 40$  and rock mass strength ( $\sigma_{cm}$ ) is less than 1 MPa, and that ripping is possible in rock masses with the GSI value in the range of 40 to 60 and  $\sigma_{cm}$  strength of up to 10 MPa. However, if the rock mass has a value of  $GSI > 60$  and the strength  $> 15$  MPa, the only applicable excavation method is blasting.

### 2.3. Tsiambos & Saroglou Method

Tsiambos & Saroglou (2010) proposed a rock mass classification method with respect to the ease of excavation, based on GSI and PLTi normalized for cylindrical specimens that are 50 mm in diameter ( $I_{s50}$ ). As a result of their research, two classification GSI diagrams were proposed, the first for rock masses with  $I_{s50}$  values below 3 MPa (Figure 4) and the second for rock masses with  $I_{s50} \geq 3$  MPa (Figure 5). It was found that blasting is required when GSI values are greater than 60. Successful ripping is generally achieved for rock masses with

GSI values between 20 and 45. In the transitional zone between the ripping and blasting areas of the GSI charts, excavation with hydraulic breakers is necessary.

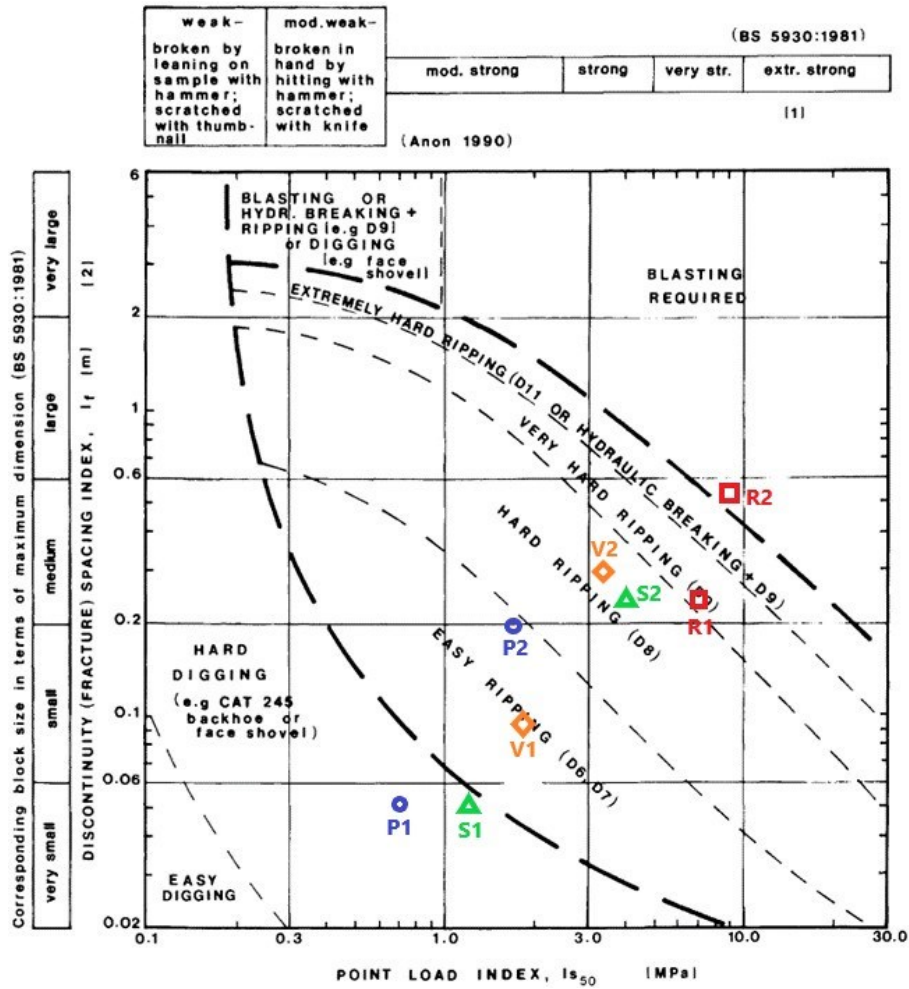

Figure 2. The chart for excavation assessing proposed by Pettifer & Fookes (1994), with added data from the present study

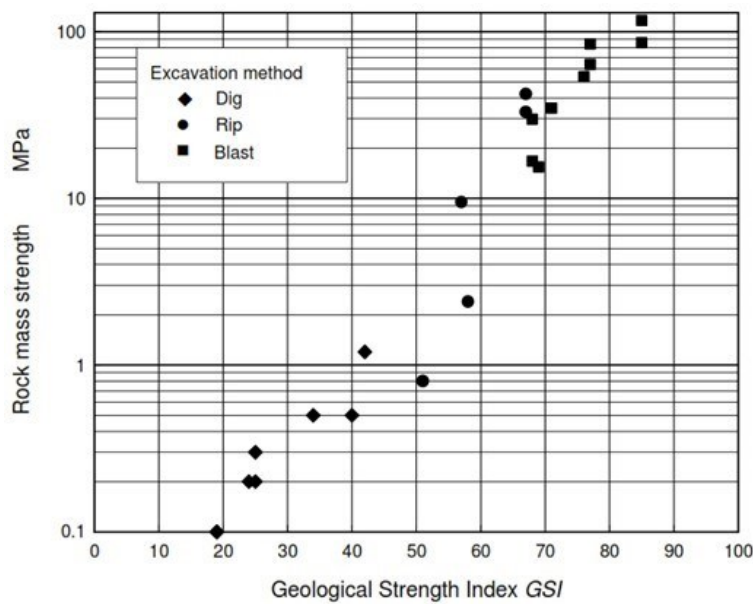

Figure 3. Plot of rock mass strength versus GSI for different excavation methods, after Abdullatif and Cruden (1983)

### 3. CAREFUL BLASTING

Mining works must be carried out technologically, technically and organizationally in order to ensure the protection of people, natural and constructed buildings, equipment, environment, etc. The most common by-product of blasting is damage to surrounding structures as a result of soil vibrations.

Blasting seismic waves causes mechanical movements of the soil, which represent non-stationary periodic oscillations (Figure 1). When seismic waves reach a structure, part of the energy of the ground oscillation is transferred to its foundations, so that dynamic stresses occur in some parts of the structure. At a given earthquake intensity, these stresses can exceed the ultimate strength of the material from which the structure is constructed, and permanent deformation can occur. The degree of damages thus caused depends directly on the oscillation velocity of the building and the soil particles.

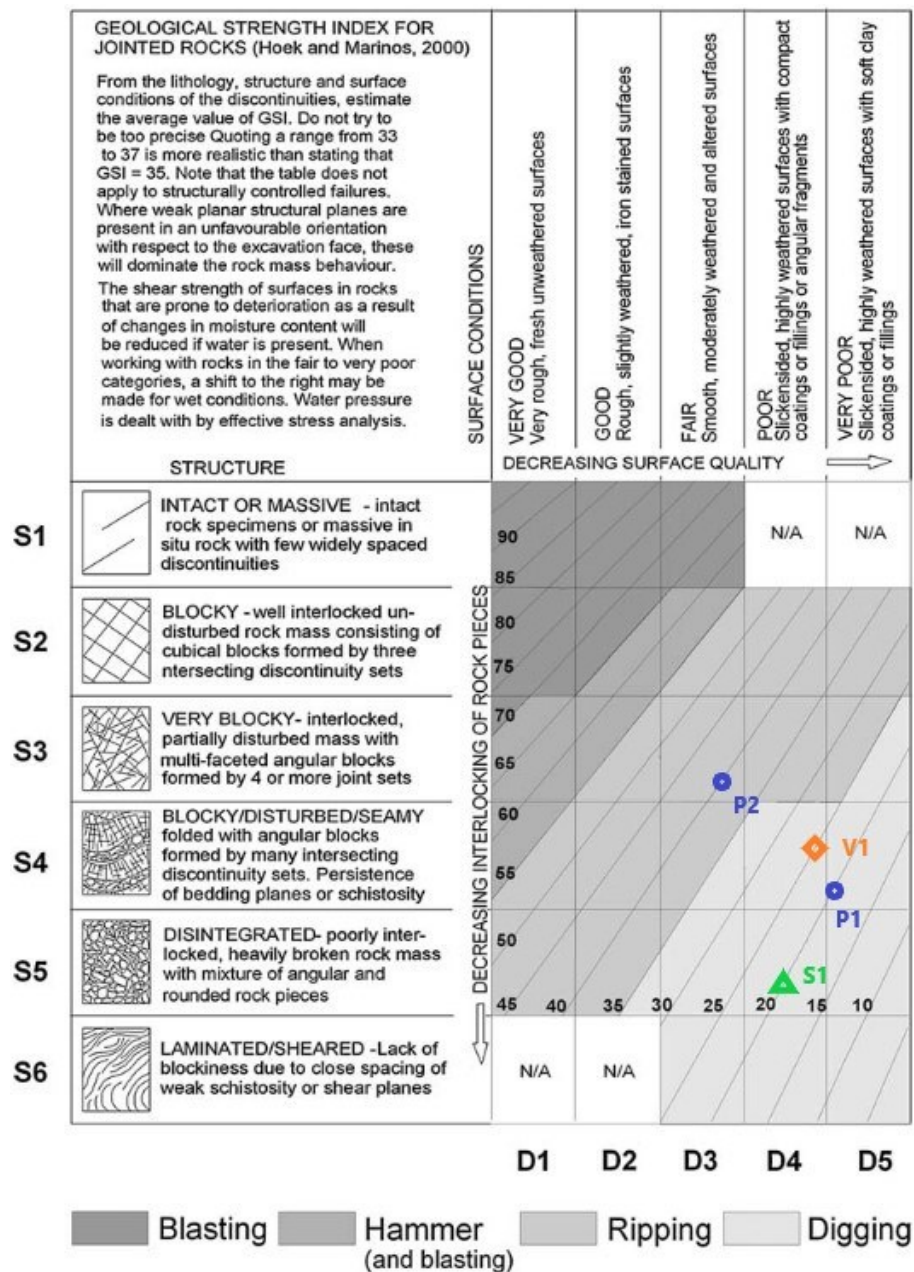

Figure 4. Classification GSI diagram for rock masses with  $I_{s50}$  values below 3 MPa proposed by Tsiambaos & Saroglou (2010), with added data from the present study

#### 3.1. Measuring of ground oscillations velocity during blasting

For blasting operations that take place without adverse effects, it is necessary to perform field measurements of the ground oscillation velocity during blasting. Seismograph instruments are used to measure the magnitudes of soil oscillations. The measuring instruments are equipped with three-component geophones, which record the

velocities of the three components of ground oscillations. This is possible because the three-component geophone consists of three geophones arranged in three spatial, mutually perpendicular axes and mechanically connected in one unit as follows:

- Two geophones placed in the horizontal plane. One in the direction of the blasting point (for registration of the longitudinal component, indicated by 1 in **Figure 6**). The other perpendicular to the previous one (for registration of the transversal component, indicated by 2 in **Figure 6**).
- A third geophone is perpendicular to the horizontal plane (to register the vertical component of the oscillations, indicated by 3 in **Figure 6**).

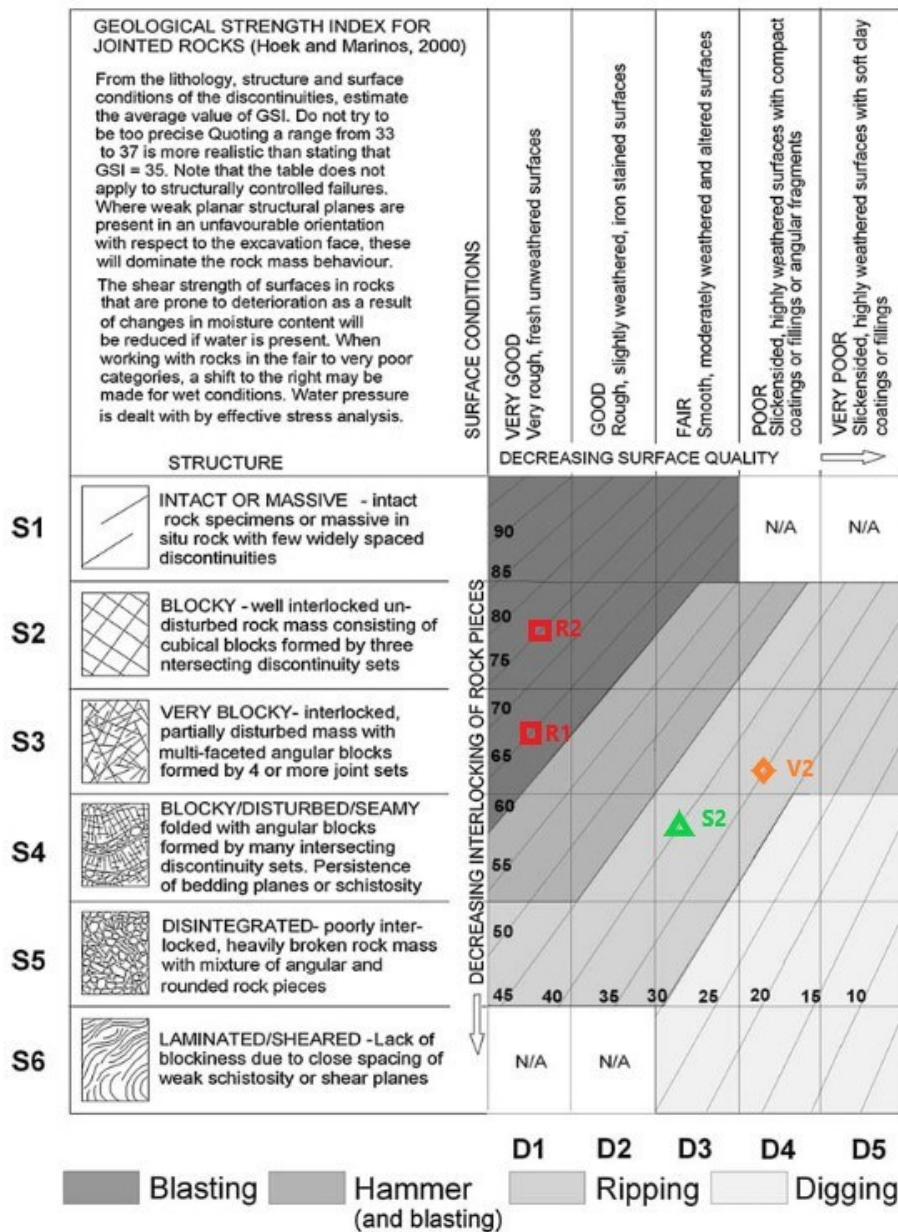

Figure 5. Classification GSI diagram for rock masses with  $I_{s50} \geq 3$  MPa proposed by Tsiambaos & Saroglou (2010), with added data from the present study

After the detonation of the explosives, each geophone registers one irregular curve obtained on the seismogram. Then the velocities of the individual oscillation components are calculated ( $V_L$  is longitudinal,  $V_T$  is transversal, and  $V_V$  is the vertical component of oscillations). The resultant velocity of ground oscillations  $V_R$  is equal to the vector sum of the velocities of the individual oscillation components (**Equation 1**), which are taken from the seismogram at the time of the greatest disturbance.

$$V_R = \sqrt{V_L^2 + V_T^2 + V_V^2} \quad (1)$$

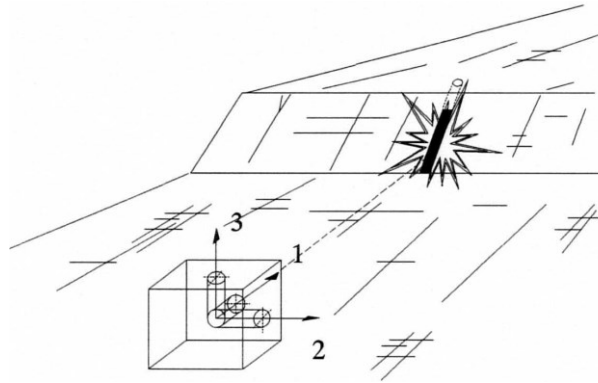

Figure 6. Orientation of geophones in relation to the blasting site (Božić 1998)

### 3.2. A criterion for seismic hazard assessment in blasting

Blasting vibrations are influenced by a number of factors, such as physical-mechanical properties and geological structure of the rock mass through which seismic waves propagate, the amount and type of explosive charge, the manner and sizes of blasting, and the distance from the blasting site. The intensity of oscillations is expressed in various measuring values such as displacement, velocity, acceleration, frequency or energy of oscillations. Which of these values best represents the intensity of the seismic effect remains an open question, so different criteria are used to assess the seismic hazard.

In Croatia, buildings are classified according to categories by standard (HRN DIN 4150-3:2011), and the permitted ground oscillation velocities are determined according to the frequency of oscillations. A graphical representation of the limit values for permissible ground oscillation values is given in Figure 7.

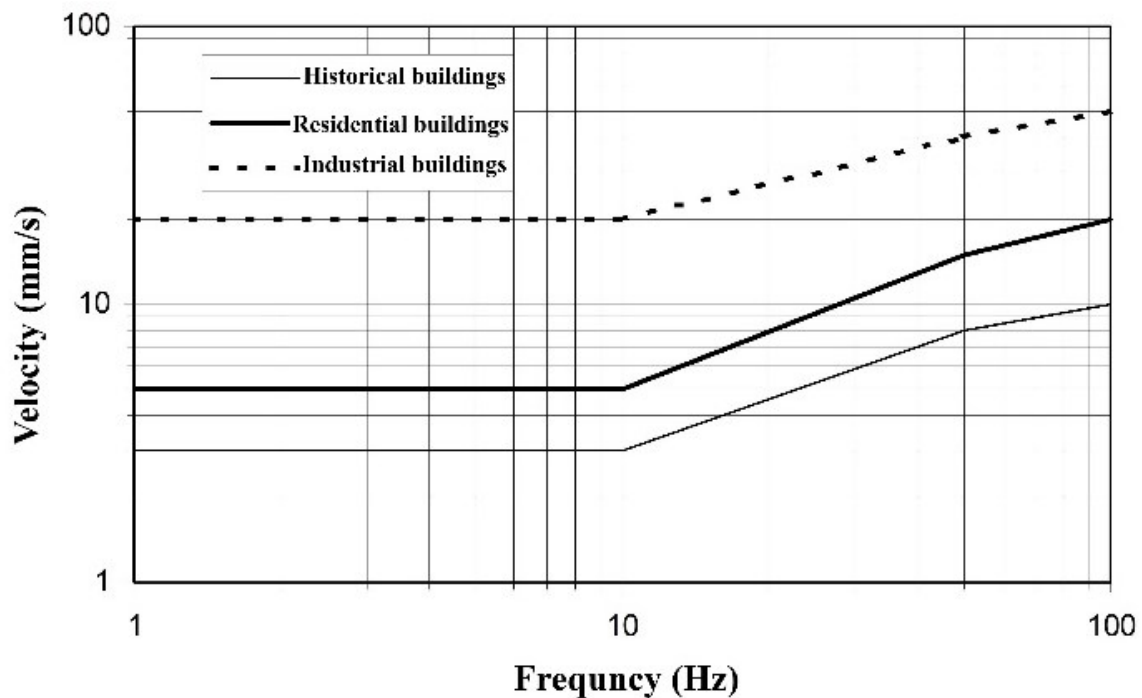

Figure 7. Diagram of limit values of permissible ground oscillation velocities (according to HRN DIN 4150-3:2011)

## 4. FIELD AND LABORATORY INVESTIGATIONS

Investigations have been carried out on four sedimentary rock sites in the karst area of Croatia, before excavation. The aim of investigations was to collect the rock mass parameters required for classification according to the methods in Chapter 2. All field investigations and laboratory testing were conducted in accordance with the International Society for Rock Mechanics suggested methods (ISRM 1981; 2007).



#### 4.1. Study sites and geological settings

According to the basic geological map of Croatia (Figure 8), the local geology of the sites is as follows:

1. Pula - the investigated area is composed of massive Cretaceous deposits, which correspond to thinly stratified limestones with rare deposits of dolomite, marl and breccia.
2. Rijeka - the location is composed of Cretaceous carbonates, which correspond to thinner or thicker layered limestones.
3. Split - the investigated area of the project is composed of massive flysch Paleogene deposits.
4. Vrbovsko - the location is composed of massive Triassic and Jurassic sediments, which corresponds to dolomites.

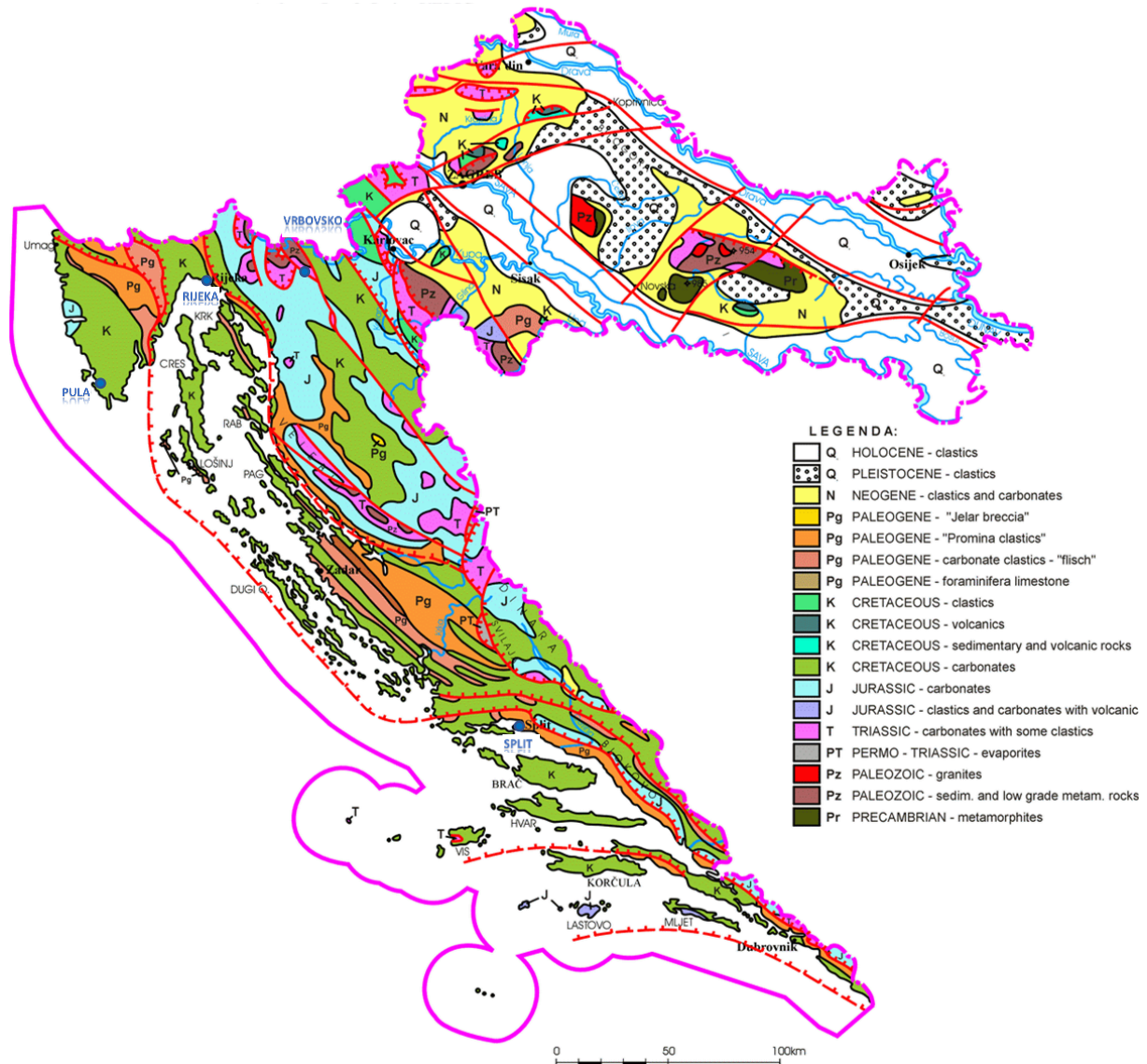

Figure 8. Basic geological map of Croatia (modified after Velić & Velić 1992)

#### 4.2. Methods of field investigations and laboratory testing

Field investigations included engineering geological mapping and exploratory core drilling. For drilling purposes, wireline equipment and a double-tube core barrel were used, which offers better recovery by isolating the rock core from the drilling fluid stream (Mayne et al. 2001). The wireline drilling equipment allows the inner tube to be uncoupled from the outer tube and raised rapidly to the surface by means of a wireline hoist. Clear water is used as drilling fluid. The field characterisation of rock masses in terms of rock type consists of determining the geological strength index (GSI) and fracture spacing index ( $I_f$ ) from drill core.

Laboratory tests on samples of intact rock from boreholes included compressive strength of intact rock samples ( $\sigma_{ci}$ ) and PLTi. The uniaxial compressive strength (UCS) tests were carried out in a hydraulic press on rock

borehole samples in the form of specimens of regular geometry (ISRM 1981; 2007).  $\sigma_{ci}$  was calculated by dividing the maximum load on the specimen during the test by the original cross-section area. PLT was carried out on borehole samples formed by regular and irregular rock cylindrical specimens. The tested samples required only some geometric minimums, with the indispensable requirement that the rupture of the specimen was produced by a fracture plane (or several) that contain the two points of the load application (ISRM 1985). PLT was normalized for cylindrical specimens that are 50 mm in diameter, obtaining the  $Is_{50}$ .

### 4.3. Practical excavations

The results of all field investigations and laboratory testing, presented in **Table 1**, were used as input data for testing and comparison three existing classifications described in Chapter 2. Data was added to the chart for excavation assessing proposed by Pettifer & Fookes (1994) (**Figure 2**) and classification diagrams proposed by Tsiambaos & Saroglou (2010) (**Figures 4 and 5**). Assessments are shown in **Table 2**, and applied excavation methods at the individual studied sites are presented in the last column.

By comparing the excavation technologies used for practical excavations and assessments of the methods for prediction of the rock mass excavatability (**Table 2**), it is observed that Hoek & Karzulovic method and Tsiambaos & Saroglou method have achieved very good assessments. The assessment of both methods was incorrect only for the Split S2 site, where the rock was excavated by digging, and the assessments were that ripping is required.

Method recommended by Pettifer & Fookes (1994) was slightly less successful. In three cases (sites R1, S2 and V1) method predicted ripping, while in one case, the excavation was carried out by blasting and in two cases by digging (**Table 2**).

**Table 1. Results of field investigations and laboratory tests on samples of intact rock from boreholes**

SITE	ROCK TYPE	DATA ID	$\sigma_{ci}$ (MPa) AVERAGE	$\sigma_{cm}$ (MPa) AVERAGE	$Is_{50}$ (MPa) AVERAGE	GSI AVERAGE	$I_f$ (m) AVERAGE
Pula	Limestone	P1	11.5	0.5	0.64	20	0.05
		P2	35.5	3	1.85	40	0.2
Rijeka	Limestone	R1	143	15	7.16	65	0.25
		R2	178	20	9.12	75	0.50
Split	Flysch	S1	16	0.5	1.21	20	0.01
		S2	41	3	4.06	40	0.25
Vrbovsko	Dolomite	V1	42	2	1.91	25	0.1
		V2	74.5	4	3.39	35	0.3

**Table 2. Assessments of existing classifications and selected practical excavation**

SITE	ROCK TYPE	DATA ID	PETTIFER AND FOOKES (1994)	HOEK AND KARZULOVIC (2000)	TSIAMBAOS AND SAROGLOU (2010)	PRACTICAL EXCAVATION TECHNOLOGY
Pula	Limestone	P1	Hard Digging	Dig	Digging	Digging
		P2	Easy Ripping	Rip	Ripping	Ripping
Rijeka	Limestone	R1	Very Hard Ripping	Blast	Blasting	Blasting
		R2	Blasting Required	Blast	Blasting	Blasting
Split	Flysch	S1	Hard Digging	Dig	Digging	Digging
		S2	Hard Ripping	Rip	Ripping	Digging
Vrbovsko	Dolomite	V1	Easy Ripping	Dig	Digging	Digging
		V2	Hard Ripping	Rip	Ripping	Ripping

On study site in Rijeka blasting could not be avoided, because there is no mechanical technology for excavation rock mass so good quality. For the purpose of constructing a building in Rijeka, a construction pit had to be excavated with blasting works. Therefore, it was necessary to design and perform careful blasting in order to minimize the impact of rock mass excavation on the environment.

In order to carry out special blasting operations in the urban area, without adverse consequences, it was necessary to make previous investigations. Therefore, field measurements of the ground vibrations during trial blasting were performed with InstanTel Minimate Plus seismograph, as described in Chapter 3.1., next to the residential building closest to the blasting site.



techniques for reducing soil vibration during blasting are known in the mining profession, but it has been shown that using the optimal explosive charge weight in one interval is a good and simple solution. By reducing the blast hole diameter, the consumption of explosives decreases and the optimal level of charge weight is reached.

## 6. ACKNOWLEDGMENTS

The authors are very grateful to the companies SPP d.o.o. and Geomin d.o.o. for providing logistic support, field and laboratory work and practical excavations. The comments and corrections made by Prof. Stjepan Strelec and Assoc. Prof. Petar Hrženjak has improved the paper considerably and are duly acknowledged.

## 7. REFERENCES

- Abdullatif OM, Cruden DM (1983) The relationship between rock mass quality and ease of excavation. *Bull Eng Geol Environ* 28:183-187
- Ainalis D, Kaufmann O, Tshibangu JP, Verlinden O, Kouroussis G (2017) Modelling the Source of Blasting for the Numerical Simulation of Blast-Induced Ground Vibrations: A Review. *Rock Mech Rock Eng.* doi:10.1007/s00603-016-1101-2
- Božić B (1998) *Miniranje u rudarstvu, graditeljstvu i geotehnici*, Sveučilišni udžbenik, Geotehnički fakultet, Varaždin, Hrvatska
- Broch E, Franklin JA (1972) The Point Load Strength Test. *Int Journal Rock Mech Min Sci* 9:669-697
- Caterpillar Inc. (2015) *Caterpillar performance handbook*. Edition 45, Caterpillar Inc., Peoria, Illinois, USA
- Church HK (1981) *Excavation handbook*. McGraw-Hill Inc., New York, USA
- Dhekne PY (2015) Environmental Impacts of Rock Blasting and Their Mitigation. *International Journal of Chemical, Environmental & Biological Sciences (IJCEBS)* 3(1):46-50
- Franklin JA, Broch E, Walton G (1971) Logging the mechanical character of rock. *Trans. Institution of Mining and Metallurgy* 80:A1-A9
- Hoek E, Marinos P, Benissi M (1998) Applicability of the Geological Strength Index classification for very weak and sheared rock masses. The case of the Athens Schist Formation. *Bull Eng Geol Environ* 57:151-160
- Hoek E, Karzulovic A (2000) Rock mass properties for surface mines. In: W.A. Hustralid, M.K. McCarter and D.J.A. van Zyl, eds. *Slope Stability in Surface Mining*. Littleton, CO: Society for Mining, Metallurgical and Exploration (SME) 59-70
- HRN DIN 4150-3:2011 (2011) *Vibrations in buildings - Part 3: Effect on structures (DIN 4150-3:1999)*. Croatian Standards Institute, Zagreb
- Instantel Inc. (2015) *Blastware Operator Manual*. Ottawa, Ontario, Canada
- International Society for Rock Mechanics ISRM (1981) *Rock characterization, testing and monitoring*. In: Brown ET (ed) *ISRM suggested methods*. Pergamon Press, Oxford
- International Society for Rock Mechanics ISRM (1985) *Point load test, suggested method for determining point load strength*. *Int J Rock Mech Min Sci and Geomech Abstr* 22:51-60
- International Society for Rock Mechanics ISRM (2007) *The Blue Book: "The Complete ISRM Suggested Methods for Rock Characterization, Testing and Monitoring:1974-2006"*, Edited by R. Ulusay and J.A. Hudson
- Langefors U, Kihlstrom B, Westerberg H (1957) *Ground Vibrations in Blasting*. Water Power, New York
- Mayne PW, Christopher BR, DeJong J (2001) *Manual on Subsurface Investigations*. National Highway Institute, Publication No. FHWA NHI-01-031, Washington, USA
- Mesec J, Težak D, Jug J (2018) Reducing the adverse effects of blasting on the cave ecosystem near the future exploitation field Gradusa. *Rudarsko-geološko-naftni zbornik* 33(4):45-54. doi:10.17794/rgn.2018.4.4
- Pettifer GS, Fookes PG (1994) A revision of the graphical method for assessing the excavability of rock. *Q J Eng Geol. Hydrogeol* 27:145-164
- Tomberg T, Toomik A (1999) Environmental Impact of Mine Blasting. *Environment Technology*. doi:10.17770/etr1999vol1.1872
- Tsiambaos G, Saroglou H (2010) Excavability assessment of rock masses using the Geological Strength Index (GSI). *Bull Eng Geol Environ* 69:13-27
- Velić I, Velić J (1992) *Cover for Geologia Croatica*, Vol 45
- Weaver, JM (1975) Geological factors significant in the assessment of rippability. *Civil Engineering in South Africa, Siviele Ingenieurswese*, 17(12):313-316

## ANCIENT CITY CONNECTED WITH THE NAME OF THE WELL "KHEYVAQ"

Gavkhar Durdiyeva<sup>1\*</sup>, Adilbek Zargarov<sup>1</sup>, Ergashbek Salayev<sup>1</sup>

<sup>1</sup> Khorezm Mamun Academy, regional branch of Academy of Sciences of the Republic of Uzbekistan, Markaz №1, Khiva city, Republic of Uzbekistan

\*E-mail of corresponding author: [gavhar61@mail.ru](mailto:gavhar61@mail.ru).

**Abstract:** In this article analytical information and facts about ancient monuments that play a main role in the 2500 years' history of Khiva, monuments of Museum reserve of Ichan Kala which locate on 26 hectares, The well Kheyvaq that is considered cultural and precious heritage of Khiva, The Gates of Ichan Kala and the walls in the length of 2600 meters that surround totally 54 ancient monuments, are presented.

**Keywords:** Ichan Kala, Deshan Kala, architectural monument, kheyvaq, well, gates.

Received: 6.5.2020. / Accepted: 02.06.2020.

Published online: 10.07.2020.

Professional paper

<https://doi.org/10.37023/ce.7.1.5>

### 1. INTRODUCTION

Today it is one of the main tasks for each native to learn and research information related to Khiva. Because this city has the ancient history in the world civilization like Rome, Egypt and Mesopotamia.

Taking into account the special role of Khiva in the development of world culture, the 28<sup>th</sup> session of the UNESCO General Conference held in Paris in October-November 1995 adopted a resolution to celebrate the 2500<sup>th</sup> anniversary of Khiva worldwide. On October 20, 1997, the 2500-year anniversary of Khiva was widely celebrated ([Khiva 1997](#)). Ichan-Kala, considered as a miracle of Khiva, was recognized as the only reserve in Central Asia in 1967, and in December 1990 was included in UNESCO's list of world culture and heritage and the city was given the high status of "Khiva - an open-air museum city!" (**Figure 1**)

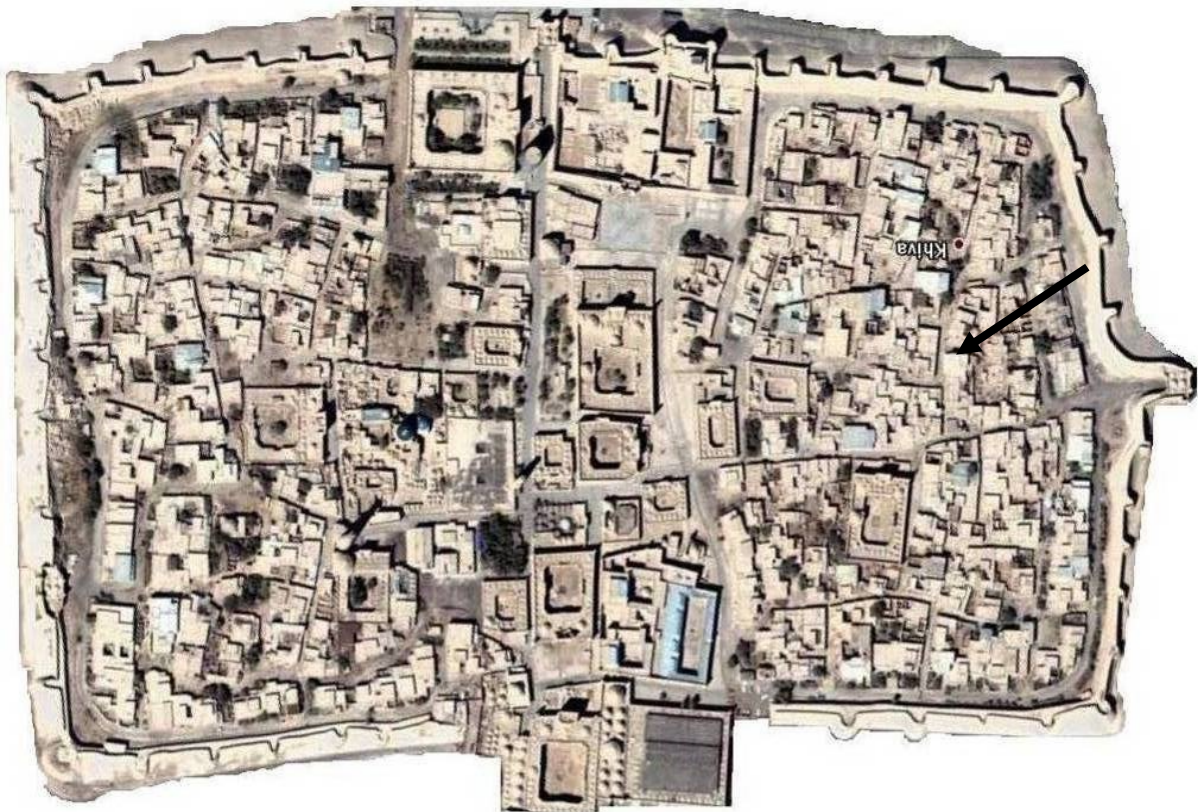

**Figure 1.** An aerial photo of the Museum reserve of Ichan Kala where the well "Kheyvaq" is located

This figure was taken by google map.

As the First President of Uzbekistan, Islam Karimov said, "Khiva is the pearl of our beautiful country, a symbol of the art and creativity of our people, a miracle that embodies the eternity of our cultural and spiritual traditions".



**Figure 2.** The aerial photo of north-western part of the walls of Ichan Kala.  
This photo was taken by author of this article.

## 2. THE MUD WALLS OF ICHAN KALA

The main elements of the ancient antique cities are the castle walls. Its main purpose is to protect the city from its external enemies. The nearly 3,000-year-old city of Khiva's Ichan Kala is a pinnacle of Central Asian fortresses with its elegance, high defense, and the rising culture (Khiva 1997).

The fortress has four gates, to the south is “Tash Darvaza”, to the north is a “Bogcha Darvaza”, to the east is a “Polvon Darvaza”, and to the west is the “Ota Darvaza”. During the Khiva khanate, there were several cemeteries around the fortress (Gulamov 1941). According to the old men, these graves were set up so that enemy soldiers, who understood the Muslim pillars in the invasion wars, could not pass through the tombs, that is, to attack the fortress from the place where the graves were located (Figure 3).



**Figure 3.** The cemetery around the fortress wall near Tash Darvaza of the Ichan Kala Museum-Reserve.  
Southern part of Ichan Kala. This photo was taken by author of this article.

By the beginning of the 20<sup>th</sup> century, Ichan-Kala had become an inner city with a whole complex of architectural composition. The wall of the Deshan Kala was formed around the Ichan Kala. The town was inhabited by the poor, artisans, and small merchants.

In some parts of the fortress where thickness of the walls is up to 8-10 meters, three rooms were created alongside the length of the walls. In the **Figure 4b** an entrance to inner room, just like we said above, is shown in the north part of the fortress. On the occasion of the of 2500<sup>th</sup> anniversary of Khiva an archeological research was undertaken and large bricks related to the antique period were found in the rooms.

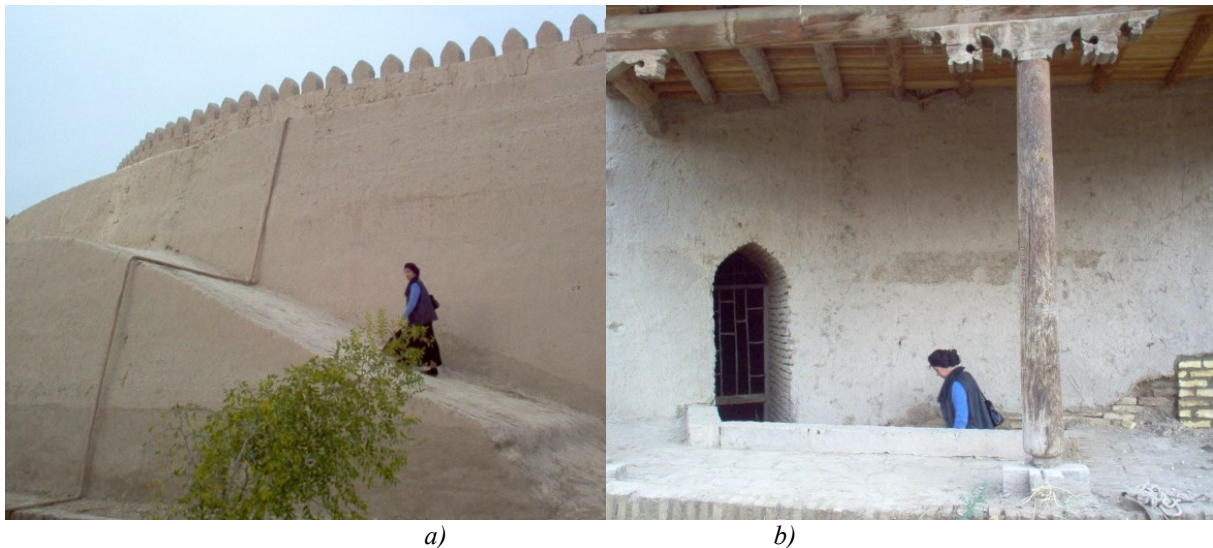

**Figure 4.** The upstairs part of the fence, in ancient times, provided food and weapons to the warriors standing in chariots (a), and the room between the wall to the north of the wall (b). In these photos the northern part of the walls of Ichan Kala was presented. These photos were taken by author of this article.

The interesting story of the Khiva historian Khudayberdi bin Awaz Muhammad is full of the ancient history of Khiva. He writes in his strange language: "Raml is another city in Khorezm. It was founded by Sam bin Nuh, now called kheyvaq. The town's former name is Raml, which means sandy. One day, Sam ibn Nuh was sleeping on this bed, and he dreamed that he was in the middle of three hundred lighted torches. He woke up happily. Then he wanted to leave a memory from himself and hesmoothed here and built a city. Another time he came here, he surrounded the place with walls and dug a well on the west side. In short, kheyvaq was said to had been destroyed and rebuilt many times".

### 3. THE STRUCTURE OF THE WELL KHEYVAQ

The bottom of the well is "hammer", the brick bottom is cylindrical, the middle part is rectangular, and the upper part is eight-sided. It is natural for every visitor to Khiva to ask, "Was there a well or had a castle been built before?" But I would say - wells first appeared.

The kheyvaq well is located in the northeastern part of Ichan-Kala near the Bogcha Darvaza, in the courtyard of a man known as the Madirim Crook (**Figure 6**).



**Figure 6.** Facade section of the ancient courtyard, where the "Kheyvaq" well is located and the old man standing next to the well. The photo on the left was taken by the author, and the one on the right was taken from the Fund of Museum-reserve of Ichan Kala.

Every story has truth, first of all, because the thing needed for life is water, people gathered around the well and started to live together, then a city was built gradually. Later the city was surrounded by walls because of the changes of sovereigns and wars.

The bottom of the Kheyvaq well is spun out of grooves. In this case, ancient craftsmen, who know how to tolerate moisture-resistant and groundwater intake as a rigid structure tree, can dig a well from 1.0 to 2.0 meters in the form of a cylinder (Figure 7).



**Figure 7.** These are the current views of the well. The top part of the well was later rebuilt with burnt bricks and the inner part was remained as it was before. Photos taken by author.

According to the book “Khorezm”, written by R. Kalandarov and others: “The stone was laid in the bottom of the Khiva well in three layers. The bottom part is cylindrical, then rectangular and the upper part is octagonal. The former was covered with a dome

In 2007, we researched the history and technical condition of the historic architectural monument of the kheyvaq well [4]. At that time, there was no water at a depth of 7.0 meters. The diameter of the well is 1.0 m. The bottom of the well, up to 1m, is made of “rosy” - “squat” and the upper part is made of stones, with a rectangular Muslim brick, of which dimension is “25.0 x 25.0 x 5cm, near the ground level and the upper part of the well.

The Ichan-Kala elders say that the eye of the well, which collects groundwater was covered with sand and soil afterwards. A man named “Sadullahoqsoqol” who once lived in the area (in the 1950s), wanted to dig the well, but the sand dug into the ground. Because of this, the well is not drilled and there is no water in the well as groundwater levels have been decreasing over the last two years.

#### 4. CONCLUSION

In conclusion Khiva saved its ancient beauty and rich in wonderful history and a beautiful city just like the ones described in the Eastern legends. Ichan Kala and Deshan Kala are unique collections of architectural monuments of XIV-XX centuries in Central Asia. Natives appreciate and take care of them. They have been proud of those places, Because there are many historical and architectural monuments and old households. The constructors, who built the ancient monuments in Khiva, knew mathematics and geodesics as well as the astronomy. And they were the best at art of architecture and succeed in urbanization too.

#### 5. REFERENCES

“Khiva – a city of thousand domes” colorful album. (1997) “Sharq” Main editorship of concern of publishing house Tashkent

Gulamov Y (1941) Monuments of Khiva city//Labours UzFAN. Number 1. History, archeology. Edition 3. Tashkent, 1941. P.24

Mankovskaya L, Bulatova V (1978) Monuments of architecture of Khorezm, Tashkent, pp 119

A scientific-technic report on the theme: “Controlling the monitoring of the architectural monuments of Ichan Kala in Khiva city and creating their data base”. Scientific-technic state system of the Republic of Uzbekistan, Grant ID-4-3, Project of Innovation. Khiva-2017



# INTEGRATION OF NATURAL ELEMENTS INTO THE TRADITIONAL HOUSE (OF KHOREZM REGION, UZBEKISTAN) FOR THE CLIMATE IMPROVEMENT

Bonu Azizova <sup>1\*</sup>, Anna Osello <sup>2</sup>

<sup>1</sup> Turin Polytechnic University in Tashkent, Kichik Khalka Yuli Str. 17, 100095 Tashkent, Uzbekistan

<sup>2</sup> Polytechnic of Turin, Corso Duca degli Abruzzi, 24 10129, Torino TO, Italy

\*E-mail of corresponding author: bonu.azizova@gmail.com

**Abstract:** This article is dedicated to the analysis and recommendations for the solution of a number of landscape problems related to architecture in the Khiva city. In particular, the advice is given on the use of methods such as "Chor-minor", "Chor-bag", which had existed in the Middle Ages.

**Keywords:** green spaces, gardens, landscape, preservation, waterways.

Received: 28.4.2020. / Accepted: 12.5.2020.

Published online: 10.07.2020.

Professional paper

<https://doi.org/10.37023/ee.7.1.6>

## 1. INTRODUCTION

Khorezm is one of the ancient regions with a very rich history. In the past, the territory of Khorezm was much larger than today, covering a certain part of the territory of Turkmenistan and the Republic of Karakalpakstan. Khorezm is bordered on the north by the Aral Sea, on the east by the Kyzylkum, on the south, on the southwest by the Karakum and the west, and on the northwest by the deserted Ustyurt Desert. The Amudarya, the largest river in Central Asia, flows along the south-eastern and north-western sides of the Khorezm region. Thus, Khorezm was separated from other regions of Central Asia due to the fact that it was surrounded by deserts on three sides. It was connected with the provinces by caravan routes, which were very scarce. The most important of these is the trade route through the banks of the Amudarya. This trade route ensured that Khorezm was in constant contact with India and the Volga region. Such a geographical location has influenced the way of life and culture of the Khorezm population (Khasanov 2015). Rural housing - the complete architecture of residential houses and the unique environment of the living environment cannot be protected without considering the territorial natural and climatic aspects. At the modern stage of architectural development, the urgency of this problem is growing day by day in connection with the protection of the environment and the growing aesthetic demands in society (Lefevre 2011; Nazarova 2013, 2014). Khorezm oasis is characterized by its dry and hot climate, temperature, winds, humidity, radiation, insulation, aeration, lighting, and landscaping are considered important factors of the climate of this region. Compared to other regions of Uzbekistan, the climate of the Khorezm oasis is much sharply variable. The Khorezm oasis is second only to Termez in terms of global warming.

## 2. MAIN CLIMATIC ZONES

Khorezm region absolute maximum temperature rises to 50 °C. At 16<sup>00</sup>, the temperature reaches its peak, at which point the sun's rays coming from the southwest side of the apartment buildings have their effect. Therefore, it is not advisable to turn the windows of the building in this direction. Windows facing this side are required to have much higher thermal resistance qualities. Many positive ideas on the use of natural and climatic conditions in the folk architecture of Khorezm have been implemented. The territory of Central Asia is divided into three main natural zones: zone I - zone of active desert climate influence (climatic zones IV A and part IV G), zone II - zone with favorable landscape-climatic conditions (climatic zones IV G and III B); III - zone with extreme cold conditions (high mountainous areas, climatic zones I B and II B). The first and second zones differ radically (sharply) from each other depending on the landscape-climatic conditions. The first zone is characterized by adverse climatic factors, and this zone is characterized by a bright-looking landscape with scattered landscape conditions. If in areas with good climatic conditions, with maximum use of the surrounding landscape, the houses will be located in the open to nature, and in the areas of the desert, where the climate is actively affected, the houses will be built indoors and compact (Mahkamov, 2019).

## 2.1. Aeration on traditional houses

Khorezm oasis belongs to the first zone, which in turn requires the organization of housing on the principle of "volumetric spatial structure" and the protection of the living environment. This principle is reflected in the organization of the indoor yard. Such an indoor yard serves as a means of accumulating cool air in the summer. The main advantage of an indoor courtyard is, of course, the protection of the apartment building from the scorching heat in the summer. The microclimate function of an indoor courtyard can be understood in two ways. First of all, the constant cool weather of the indoor yard creates good conditions for household chores and recreation for all members of the family in the hot summer season. Second, this spacious enclosed structure directs cool air to all the rooms around the courtyard and allows you to maintain a constant microclimate inside them. The speed of air flow in this oasis depends on the nature of the multi-faceted surface plane. In the periphery of the country (around) the speed of air flow is higher than in its center. At the same time, the wind is weak in the central part of the country, but its vibration amplitude is relatively low. Based on the research, the width, height and length of the building, the slope of the roof, the orientation of the building and the number of windows in it, the canopies and awnings have an impact on the speed of air flow. The Khorezm oasis is one of such elements of traditional dwelling houses - it is the installation of umbrellas over the high porch spaces.

These umbrellas create good conditions to catch the wind and allow the wind to pass directly to the innermost bottom of the yard. The natural ventilation, air exchange, aeration of the living rooms of residential houses depends on the difference in temperature inside and outside the building, as well as the thickening and thinning of the air under the influence of wind. In order for the temperature difference to create a constant air flow, the window gaps between the air outlet and the inlet must be located at different levels of the building. Khorezm residential houses require geometrization of the chilled air in the evening at some hours, and ventilation of the rooms at other hours of the day. The lighting of the rooms is subject to the rules of aeration and radiation of the interior rooms, provided that the installation of protective devices for windows is observed. It is important to place the windows relative to the sun. South-facing walls conduct less heat in summer than east-facing walls. The best orientation for summer rooms is to the north, and for winter zones, which require maximum heat, the best orientation is to the east, then the west and south sides do not lose their importance in this regard. The higher energy efficiency of solar radiation in the Khorezm oasis creates a more expedient orientation in accordance with generally accepted rules. But in addition to heat transfer through sunlight, builders also have to reckon with the lighting mode.

Although the summer rooms are mainly oriented to the north, they provide sufficient light for all conditions, as in this area in the summer there is a much longer duration of the day and the intensity of light. For winter rooms, it is necessary to choose an orientation that will ultimately achieve maximum heat and light. In winter, more south-facing walls are illuminated by sunlight, while restored walls facing east and west receive the most amount of heat. Khorezm masters in their construction practice reckon more with the long duration of the scattering of sunlight. Thus, the sides of the types of buildings are exposed to heat, which differs significantly from each other. Such diversity of thermal effects indicates that there are continuous correlations between the amounts of solar radiation and orientation received along the sides of the building where the sun's rays fall. In climatic conditions, the main components of which are rain and snow, two-sloped (sloping) roofing not only justifies itself, but also actively participates in the creation of the architectural and artistic image of rural residential buildings. Due to the low incidence of fires in the hot and dry climates of Central Asia, especially in the Khorezm oasis, double-sloped roofs do not justify themselves, both functionally and aesthetically. Low rainfall in Khorezm requires roofing on a small slope. In desert conditions, one of the ways to connect the dwelling with the external environment is to use a walled enclosed form of fencing with high thermal protection properties, as such a form provides good insulation of the house from various harmful effects of nature. In modern rural houses of Khorezm it is more common to cover the verandas with windows, which have a poor orientation to the sun. Glass-covered loggias or verandas can be allowed to orient in a northerly direction when they are protected from returning heat rays (streams). Typically, a residential courtyard on the north side of the house receives heat radiating from the direct falling rays of the rising sun as the sun sets toward the sunset (Gulyamov 1941).

## 3. FUNCTIONAL PROPERTIES OF GARDENS

The historically formed rural settlements of the Khorezm oasis are distinguished by a certain contrast of natural and mastered landscape, which has its own distinctive features. In this oasis, the main focus is on the priceless traditions of the garden in front of the residence. The gardens of the settlements of this region are characterized by the fact that the specific natural and climatic conditions of Khorezm rural houses, made of the material that forms the basis of the surrounding landscape, require consideration of the following measures:

- creation of living environment on the principle of "space within volume", as opposed to the principle of "volume in space".
- Protect the architectural environment from overheating under the influence of sunlight and increase the ventilation of this environment by orienting it to the north or northeast or at least east.
- Many Tsar-gardens that existed in the Central Asian region in the Middle Ages. None of the meadows and other types of garden structures have survived to the present day.

**Table 1.** Classification of Timurid gardens according to their functional features

№	Functional features	The names of the gardens	Year
	Gardens with palaces	1. Bagi Dilkusho 2. Bagi Nakshi Jaxon 3. Bagi Baland	1396-1399yy. 1370-yy -
II	Gardens for hunting	1. Bagi Jaxonnomo 2. Bagi Bekhisht 3. Takhta Karacha	- 1378y. -
	For the king and his family members	1. Bagi Shamal 2. Bagi Bekhisht 3. Garden Amirzoda Shahrukh	1397y. 1378y. 1394y.
III	Gardens for discussion and poetry nights	1. Bagi Boldu	-
IV	Multifunctional gardens	1. Bagi Maydan (with a pavilion garden with a playground for the game of Chovgon, with a two-story Chil-ustun Palace and a porcelain room gallery. 2. Bagi Davlati-Obod (Garden, exotic plants, legumes and vineyards)	1435-1436yy. 1399y.
V	Public parks	1. Bagi Zagan (on the way to Pandjikent) 2. Bagi Chinar (on the bank of Dargam river) 3. Bagi Nau (luxury public garden)	- - 1404y.
VI	Gardens with fortress	1. Boston Palace "Fruit Garden Palace" 2. Garden under the Blue Palace in Samarkand; Garden near the White Palace in Shakhrisabz	- 1370y. 1379y.
VII	Memorial gardens	1. Darus-Saodat family mausoleum in Shakhrisabz 2. Hodji Ahmed Waqf Park near the Yassavi Mausoleum in Turkestan 3. Parks at the Samarkand mausoleums: 4. Gori Amir 5. Workshop, 6. Hodja Ahror, 7. Abdi-Dorun 8. Abdi-Berun 9. Char-Bakr and Bahauddin in Bukhara.	- 1402-1405yy. 1397y. - - - -

Thus, based on the data on Timurid parks, it can be said that the parks are divided into 4 types (for cities, for suburbs and for recreation zones). Depending on the species, they contribute to the development of various industries. In particular, foreign and domestic industries will open new tourist destinations, such as eco-tourism, national cultural centers. In addition, boulevard and alley-shaped parks play an important role in the wide celebration of national holidays and thus in combining our ancient traditions with modern lifestyles.

## a) Garden in horizontal zone

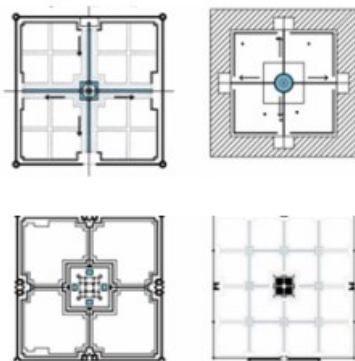

## b) Garden in the shape of perimeteric

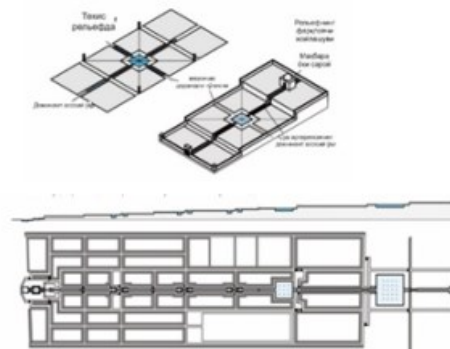

**Figure 1.** "Chor-bog" traditional water structures. Irrigation of "garden": a) horizontal surface in the plain; b) perimeter construction; c) relief plane, at a slope of 2-10%.  
The illustration is made by author.

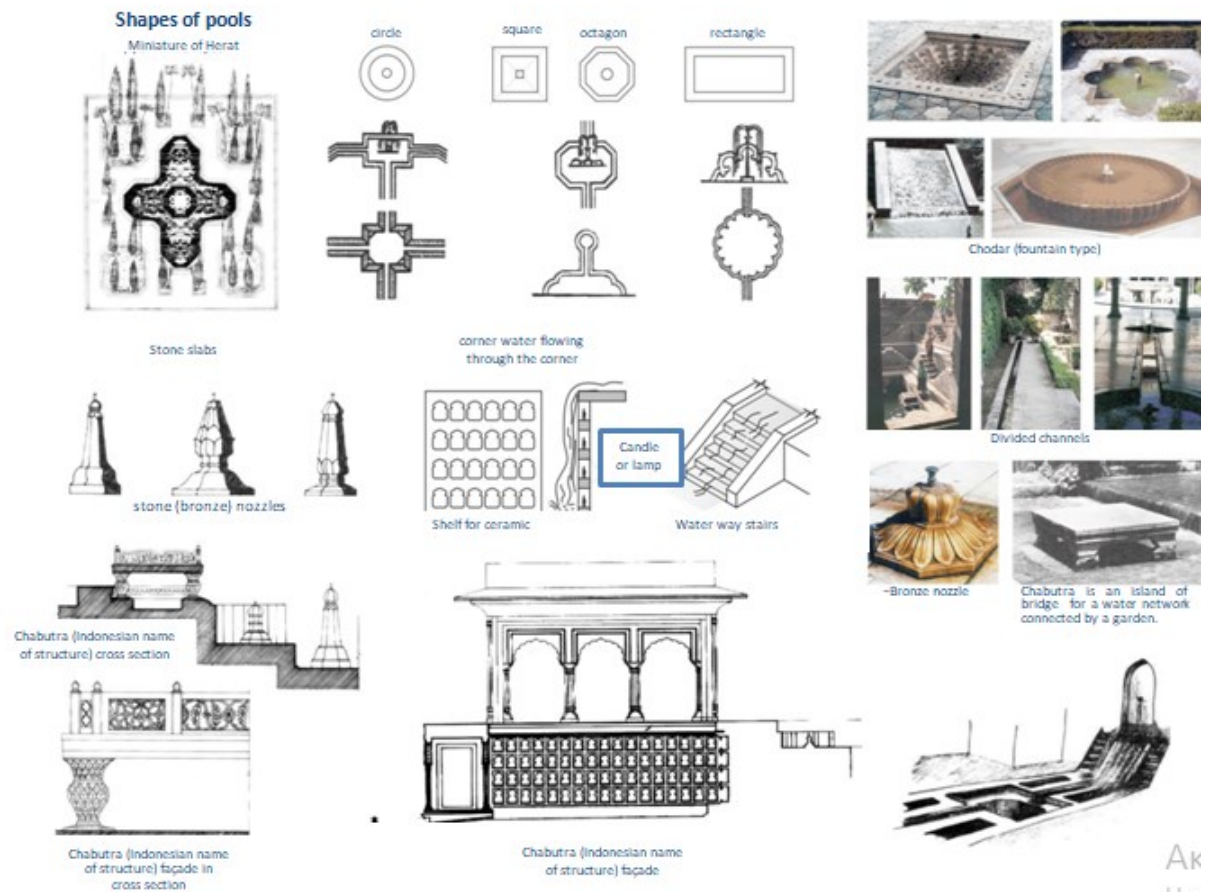

Figure 2. Recommended water basins and rock slabs for waterfalls in light differentials. The illustration is made by author.

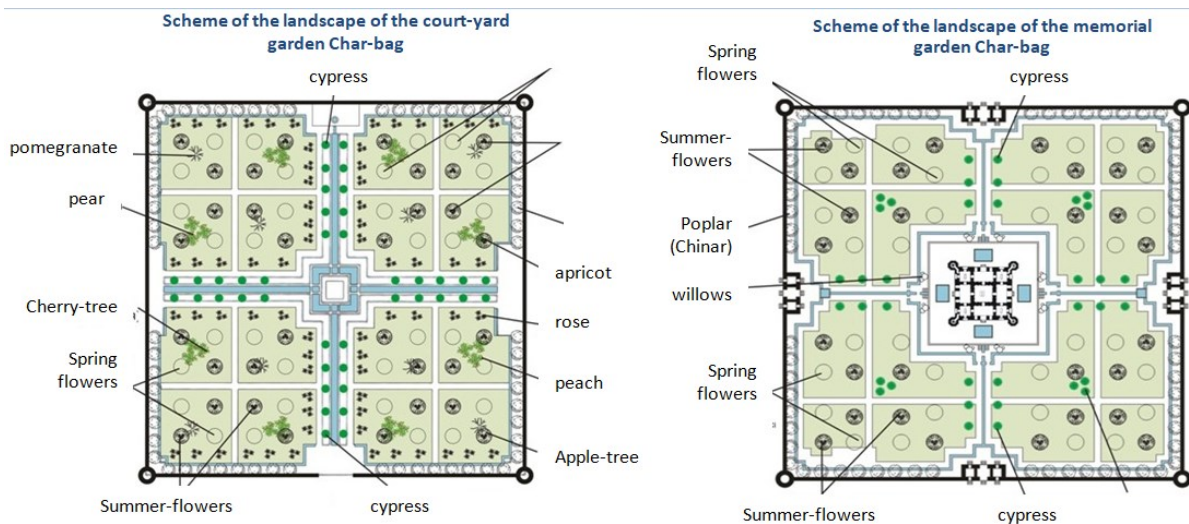

Figure 3. Requirements of the traditional scheme of landscaping "Chor-garden". The illustration is made by author

However, we can find out what it was like and in what order the trees were planted by our scientists, archaeologists and architects. In particular, the classification of these trees, developed by Akhmedov (1995, 2014), gives us a lot of information about the gardens .

**Table 2.** Psycho-emotional effects of various plant compositions (Karmazin Kakovsky, 1987)

№ types	Plant compositions and their psycho-emotional effects
1 and 2	A space with sharply connected trees and shrubs emphasizes a more orderly (disciplined) activity, as opposed to spaces with arbitrary or artistically figured trees. In our example, there is a “Chor-garden” garden planted along the perimeter of the logs along the walls.
3 and 4	In addition, geometrically cut trees and shrub shapes encourage intense activity because clearly defined and beautiful groups contribute to conflicting movements (e.g., Shalimar Park in Lahore).
5 and 6	The scheme of the plant can be directed to a specific point (in Shalimar Park, Taj Mahal, trees in asymmetrical location on both sides of the main trunk draw attention to the mausoleum) or to replace it with groups of ornamental trees.
7 and 8	Large trees lose their expressiveness when compared to trees. The comparison between large and small trees is well represented by relationships and dimensions; their position is more deeply expressed as a result of the contrasting impression (usually the Chor-Garden scheme, where high and low fruit trees are planted along the perimeter).
9 and 10	The columnar and pyramidal shapes of the trees give an idea of the height (Kashan Garden in Iran), but the width of part of the umbrella-shaped, domed trees. ("Itimod ud-State Park", "Lahore" Park).
11 and 12	A sense of stability is provided by groups of pyramidal trees, while trees gathered in the form of a bouquet cannot create stability.
13 and 14	Trees with a round, compact shape better represent ideas of completeness, perfection, yet trees planted in different directions leave a dull, unfinished impression.
15 and 16	Trees with a round or oval shape of the mountain, while festive, are also stronger than those with a columnar shape that has a serious appearance.
17-18 and 19-20	The crowns of unorganized or curved horned trees are more impressive than those with long, narrow, vertical trunks with hornless buds that rise vertically or cause a certain static impression.
21, 22 and 32	Harmony in European kindergartens is achieved not only in a symmetrical order, but can also depend on asymmetric groups. The beautiful forms of such groups sometimes leave an unforgettable impression.
23 and 24	The silhouettes of large groups of trees in the landscape can give a state of tranquility using horizontal shapes, and the stepped silhouettes create a chaotic atmosphere.
25 and 26	The silhouettes of groups with rounded upper horns (crowns) of trees create a more calming environment than those with sharp horns (crowns).
27 and 28	Compact plants with the support of compact plants represent stability, precision, safety and resilience, but compact plants with uneven crowns give the impression of uneven, safe and uncertain.
29 and 30	Plants with bright green leaves or brightly colored flowers are more noticeable if they are highlighted and placed forward in the dark hue of the trees. On the contrary, the contours of dark plants are well represented in front of them, and conversely, the contrast is drawn to a bright background.
31 and 32	Two fruit trees, such as a lemon and a citrus, a lemon and an orange, wrapped between a flowerbed or a cypress tree planted by two pairs of trees, symbolized happy lovers. They create a sense of surprise, good intentions, joy.
33 and 34	The weeping willow symbolizes the grief of the famous Majun as Lily merges with the water lily that falls into the water.
35-36 and 37-38	While the dark purple-purple, blue-black represents Lily’s hair shine and scent, jasmine is a symbol of Lily’s elegant white neck. The cypress tree is her delicate waist, the tulips and flowers are her lips and cheeks, and the narcissus flower is the hadid in her eyes.
40	The aesthetic ripening of herbaceous plants and fruits based on the principle of continuity of flowering in Central Asia is astonishing, and leads to enthusiasm, renewal. However, the choice of tree species in Europe is made according to the principle of irrigation, taking into account the fact that in autumn the leaves turn yellow and form a beautiful bouquet, which gives a melancholy mood or upset.
41	With the predominance of one type of flower, the garden areas give a strong impression of the scale of a flowerbed and its contrasts with other places. (North India).
42 and 43	Planting deciduous trees along the main axis of the garden means “eternity” and emphasizes the importance of the mausoleum or building. Planting flowers in the lateral parts of groups of fruit trees - a symbol of renewal of life and youth. (Taj Mahal).

<b>44 and 45</b>	Accepting the planting of flowers on the lowered sheets not only reflects the geometry of the design, it gives the impression that the flower is walking on the carpet. The guest touches the flowers and fills the air with pleasant scents of fragrant herbs, which bring pleasant feelings and aesthetic pleasure (the gardens of Alhazar in Seville and the courtyard of Qasir al-Mubarak).
------------------	---

**Architectural decoration of the palace**

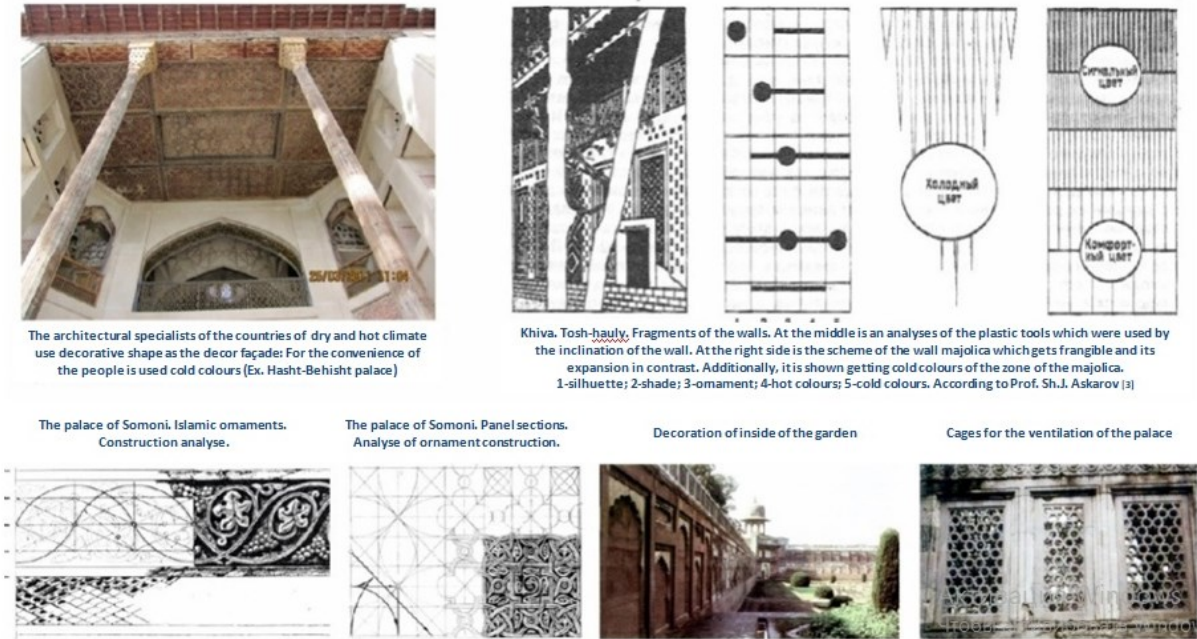

**Figure 4. Architectural decorative wall gardens.**  
The illustration is made by author according to Askarov (2009)

**Alleys and pedestrians**

The decoration of the garden construction and covering with stone, baked clay brick of the pedestrian. It is esthetic connected with Char-bag style.



**Figure 5. Use of natural materials for the walkways in the traditional garden "Chor-garden".**  
The illustration is made by author

**4. CONCLUSION**

Conflict situations in the Khiva urban landscape were assessed and on this basis measures were developed to address the problems.

The use of new innovative technologies in the landscape, in particular the use of new aspects of modern "Light Architecture" to further enhance the decorative properties of light green environments (for example, self-illuminating barriers, garlands, radiant umbrellas, self-reflecting tiles on the floors of landscape architecture, through the use of geoplastics) we can give a new tone to the quality of landscape architecture of our city.

We offer the use of historically tested methods "Chorbog", "Chorchinor" and "Chorchaman" in shaping the landscape of alleys, open and closed green spaces on the basis of national values of our art.

And eke given the hot and dry climate of our city and the long summer, it is expedient to use the opportunity to achieve the effect of "wind" in the landscaping of urban areas and in the art of gardening.

It is proposed to raise the level of architecture of open spaces to a higher level by applying various decorative compositions of mobile and container-grown flower beds in the landscaping of the fronts and sidewalks of prestigious public buildings in the city, Ichan Kala streets.

The scheme of creating a favorable environment for human life in historical centers is proposed.

## **5. ACKNOWLEDGMENTS**

My gratitude goes to the Departure of Civil engineering and Architecture, TTPU, for allowing the hours for this work.

I would like to thank the archive under the Main Department of Research and Production of Protection and Use of Cultural Heritage of the Ministry of Culture of the Republic of Uzbekistan helped us to collect data.

## **6. REFERENCES**

- Ahmedov MK (1995) The History of Central Asian Architecture. Uzbekistan Publishing House, Tashkent.
- Ahmedov MK (2014) The ways of development of medieval architectural ensembles of Uzbekistan. Tashkent: Science and technology, 2011. 29-67.
- Askarov SJ (2009) Architecture of Timurids. Sanat-Tashkent.
- Gulyamov Y (1941) Monuments of Khiva city//Labours UzFAN. Number 1. History, archeology. Edition 3. Tashkent, 1941. p.24
- Karmazin Kakovsky VY (1987) The architecture of the Boyka church. New York: 223 p.
- Khasanov AO (2015) Some questions of certain recreation great silk road route. International journal of scientific & technology research, France/India, volume 4(3):119-120
- Lefevre P (2011) Possibilities of architectures for sustainable development. Paris, Tashkent.
- Mahkamov NR (2009) The social structure of society on the territory of Uzbekistan: traditions and transformations (late 19th-30th years of the 20th century). Tashkent,
- Nazarova DA (2013) Some problems of developing cities. Arkhitektura, qurilish, dizayn, Tashkent.
- Nazarova DA (2014) Local reconstruction in the context of sustainable development of urban areas. Memorichilik va qurilish muammolari, Samarkand.

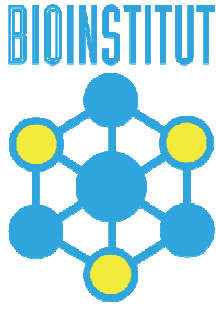

**Bioinstitut d.o.o.**

Čakovec, Rudolfa Steinera 7

telefon: 040/391-485

mob: 098/465-475

fax: 040/391-493

e-mail: [laboratorij@bioinstitut.hr](mailto:laboratorij@bioinstitut.hr)

Laboratorijska djelatnost kao jedna od vodećih na tržištu laboratorijskih usluga u Republici Hrvatskoj djeluje više od 25 godina, dok je nagli razvoj započeo 2005. g. dobivanjem prve potvrde o akreditaciji prema međunarodnoj normi HRN EN ISO/IEC 17025. Od tada se područje akreditacije svake godine kontinuirano



proširuje novim metodama ispitivanja, te je više od 180 metoda ispitivanja akreditirano prema novom izdanju norme HRN EN ISO/IEC 17025 iz 2017. g. U Laboratoriju za ekologiju ispituju se svi tipovi voda, različite vrste otpada (uključujući i kruta oporabljena goriva), tla, mulja, sedimenta i naftnih proizvoda prema važećim zakonskim propisima. Uzorkovanje obavljaju tehničari na cijelom području Hrvatske, kao i u drugim zemljama.



The Laboratory, as one of the leading laboratory services market in the Republic of Croatia, has been operating for over 25 years, while its rapid development began in 2005. obtaining the first accreditation certificate according to the international standard HRN EN ISO/IEC 17025. Since then, the field of accreditation has been continuously expanded with new test methods every year, and now more than 180 test methods have been accredited according to the new edition of HRN EN ISO/IEC 17025 of 2017. All types of water, different types of waste (including solid recovered fuels), soil, sludge, sediment and petroleum products are tested at the Ecology Laboratory in accordance with applicable legal regulations. Sampling is performed by technicians throughout Croatia as well as in other countries.





### **OIKON Ltd. - Institute of Applied Ecology**

is a **leading licensed and accredited environmental consultancy/research institute** in Croatia and the region.

The company provides its clients with high-quality and innovative services and solutions in the field of **environmental and nature protection, sustainable management of natural resources and environmental law, policy and economics.**

- ✓ **20** years of experience
- ✓ **1,300** contracts
- ✓ **300** clients
- ✓ **4** departments
- ✓ **3** laboratories
- ✓ **8** doctors of science

#### **OIKON Ltd.—Institute of Applied Ecology**

Trg senjskih uskoka 1-2  
10 020 Zagreb, Croatia



[www.oikon.hr](http://www.oikon.hr)

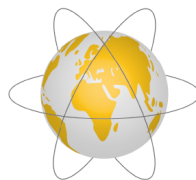

**UNIGIS** Zagreb  
Studying Geoinformatics Online

Enhancing the competence of **GIS professionals** with two **distance learning** programmes certified by the **University of Salzburg**

<b>MASTER OF SCIENCE</b> 2 – 3 years Academic Degree - MSc(GIS)	<b>UNIGIS PROFESSIONAL</b> 1 – 1,5 year(s) Academic Certificate in GIS
---	--

For more info contact us at:

**OIKON Ltd. - Institute of Applied Ecology**  
**Study Centre for South East Europe**

E: [office.zagreb@unigis.net](mailto:office.zagreb@unigis.net)

T: +385 1 5507 154



[www.unigis.at/en/zagreb](http://www.unigis.at/en/zagreb)





Sveučilište u Zagrebu  
GEOTEHNIČKI FAKULTET  
Zavod za geotehniku



## ZAŠTO SURADIVATI S NAMA

Stručno osposobljeni djelatnici  
Suvremena geomehanička oprema  
Standardne i specijalne metode ispitivanja  
Suradnja u nastavnom programu fakulteta  
Suradnja u znanstvenim projektima fakulteta  
Suradnja s gospodarstvom

**KONTAKTIRAJTE NAS**

Adresa  
HALLEROVA ALEJA 7,  
42000 VARAŽDIN

Telefon  
042 408 938

Fax  
042 313 587

Mobitel (Voditelj laboratorija)  
091 408 9007

E-mail  
geolab@gfv.unizg.hr  
geolab.gfv@gmail.com

Adress  
HALLEROVA ALEJA 7,  
Hr-42000 VARAŽDIN

Telephone  
+385 42 408 938

Fax  
+385 42 313 587

Mobile(Laboratory manager)  
+385 91 408 9007

E-mail  
geolab@gfv.unizg.hr  
geolab.gfv@gmail.com

**CONTACT US**

od 1974

since 1974

Professionally trained employees  
Modern geomechanical equipment  
Standard and special test methods  
Collaboration in the faculty curriculum  
Collaboration in faculty scientific projects  
Cooperation with the economy

**WHY COOPERATE WITH US**

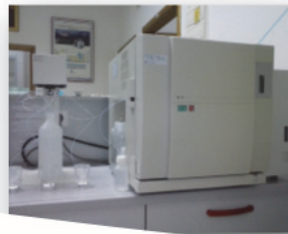
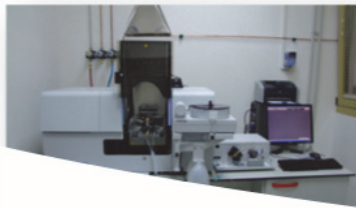

SVEUČILIŠTE U ZAGREBU  
GEOTEHNIČKI FAKULTET  
Hallerova aleja 7, 42 000 VARAŽDIN  
tel.: 042 / 408 - 900  
fax: 042 / 313 - 587  
M.B. 03042316



GEOTEHNIČKI FAKULTET  
Zavod za hidrotehniku  
Laboratorij za geokemiju okoliša  
tel.: 042 / 408 - 937  
fax: 042 / 313 - 587



## LABORATORIJ ZA GEOKEMIJU OKOLIŠA

- osnovan je 2006. godine sa znanstvenom, stručnom i obrazovnom svrhom
- opremljen instrumentima i pratećom opremom za prikupljanje uzoraka tala, sedimenata, prirodnih i otpadnih voda
- vrši terenske i laboratorijske analize prikupljenih uzoraka
- obavlja usluge agrokemijskih analiza tla za poljoprivrednike na temelju kojih se daje preporuka za gnojidbu

Zavod za hidrotehniku



## LABORATORIJ ZA GEOKEMIJU OKOLIŠA

Tel.: 042 / 408 - 937

Fax: 042 / 313 - 587

E-mail: lgo@gfv.unizg.hr

## LABORATORIJ ZA GEOKEMIJU OKOLIŠA

Laboratorij za geokemiju okoliša osnovan je u sklopu Zavoda za hidrotehniku Geotehničkog fakulteta u Varaždinu. Laboratorij sudjeluje u izvođenju praktične nastave iz kolegija preddiplomskog i diplomskog studija te Zdrženog međunarodnog doktorskog studija kao i u znanstvenim te stručnim projektima. Na taj način ispunjava svoju obrazovnu, znanstvenu i stručnu svrhu. Smješten je na 100 m<sup>2</sup> prostora i opremljen modernom opremom za provedbu geokemijskih terenskih i laboratorijskih ispitivanja, što uključuje prikupljanje uzoraka tla, sedimenata i vode. U laboratoriju se obavljaju i usluge agrokemijskih analiza tla.

### Pokazatelji koje mjerimo u uzorcima voda, eluata tala i sedimenata:

- ~ atomskom apsorpcijskom spektrometrijom: Al, As, B, Ba, Ca, Cd, Co, Cr, Cu, Fe, Hg, K, Li, Mg, Mn, Mo, Na, Ni, Pb, Se, Si, Sr, Ti, V, Zn
- ~ amonijak, nitriti, nitriti, ukupni dušik
- ~ bromidi, fenoli, fluorida, fosfati, jodidi, kloridi
- ~ silikati, sulfidi, sulfati, sulfiti
- ~ suspendirana tvar, mutnoća, KPK
- ~ alkalitet, ukupna tvrdoća, karbonatna tvrdoća, nekarbonatna tvrdoća, kalcijeva tvrdoća, magnezijeva tvrdoća
- ~ slobodni CO<sub>2</sub>, koncentracija otopljenog kisika i zasićenost kisikom
- ~ pH, električna vodljivost, ukupna otopljena tvar - TDS
- ~ trasiranje podzemnih tokova (koncentracija natrijevog fluoresceina)
- ~ ukupni organski ugljik i ukupni dušik - TOC/DOC/TN
- ~ razaranje tla zlatotopkom
- ~ ekstrakcija izmjenjivih kationa iz tla amonijevim acetatom i kalijevim kloridom



Ispitivanje fizikalnih i kemijskih svojstava prirodnih i otpadnih voda.



Provođenje agrokemijskih analiza tla u svrhu modernizacije poljoprivredne proizvodnje, racionalizacije gnojidbe, povećanja prinosa i zaštite prirodnih resursa.



Ispitivanje sastava eluata otpada.



Određivanje pH, pKCl, ukupnog CaCO<sub>3</sub>, NO<sub>3</sub><sup>-</sup>, NO<sub>2</sub><sup>-</sup>, NH<sub>4</sub><sup>+</sup>, fosfora i kalija, humusa, teških metala i drugih kemijskih svojstava tla.

**Kontakt:** izv.prof.dr.sc. Anita Ptčec Siročić  
voditeljica laboratorija  
tel: 042 / 408 - 957  
e-mail: anita.ptceck.sirocic@gfv.unizg.hr

dr.sc. Dragana Dogačić  
stručna suradnica  
tel: 042 / 408 - 956 ili 042 / 408 - 937  
e-mail: ddogan@gfv.unizg.hr

Saša Zavrtnik, dr.med.vet.  
laborant  
tel: 042 / 408 - 937  
e-mail: lgo@gfv.unizg.hr



## ZAVOD ZA GEOTEHNIKU GEOFIZIČKO-GEOTEHNIČKI ISTRAŽNI RADovi



### GEOFIZIČKI ISTRAŽNI RADovi

- Geoelektrična istraživanja (sondiranje, profiliranje, tomografija)
- Seizmička refrakcija (P i S valovi)
- Višekanalna analiza površinskih valova (MASW)
- Seizmička karotaža
- Seizmički efekti miniranja
- Mikrotremor
- Georadar

### GEOTEHNIČKI ISTRAŽNI RADovi

- Istražno bušenje u svim vrstama tla i stijena
- Statički penetracijski test (CPT, CPTU, SCPT)
- Standardni penetracijski test (SPT)
- Bušenje, ugradnja i pokusno crpljenje zdenaca i piezometara
- Izrada geotehničke dokumentacije (izvješća, elaborati, projekti)
- Geotehnički nadzor i savjetovanje



# UNIVERSITY OF ZAGREB FACULTY OF GEOTECHNICAL ENGINEERING DEPARTMENT OF HYDROTECHNICS



## Main research areas:

- Water management
- Groundwater protection
- Hydrology
- Hydrogeochemistry
- Advanced technologies for water treatment

## Experience and knowledge transfer applications:

- Preparation of methodology for karstic groundwater bodies quality status and risk assessment
- Preparation of national methodology for status assessment of coastal karstic groundwater bodies
- Delineation of drinking water protection zones and protection measures
- Preparation of mathematical models of intergranular aquifers

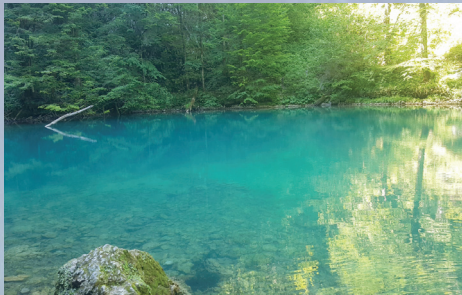
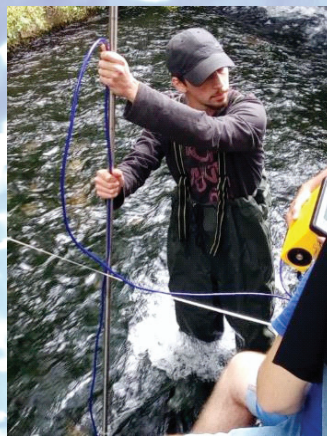

## GRADUATE STUDY OF ENVIRONMENTAL ENGINEERING WATER MANAGEMENT





**WINDOR® d.o.o.**  
A. Buk 54a, HR- 34310 Pleternica  
T. +385.34.268.002  
E. kontakt@windor.hr  
W. www.windor.hr

## ULTRA AD 77

Aluminij-drvo prozor

### Vrhunac dugoročnog ulaganja u istraživanje i razvoj

Savršen spoj slavonskog masivnog hrasta iznutra, koji interijer čini ugodnim i toplim te aluminija izvana koji štiti od vanjskih utjecaja i jednostavan je za održavanje.

Stolarija pruža izvrsnu toplinsku izolaciju; u profile se ubrizgavaju PUR profili što u konačnici poboljšava ukupni toplinski koeficijent prozora.

### Prirodni materijali i moderan dizajn

- jedinstveni profili na tržištu
- konkurentna cijena proizvoda
- visoka kvaliteta izrade i ugradnje
- profesionalni pristup
- garancija na ugrađene proizvode

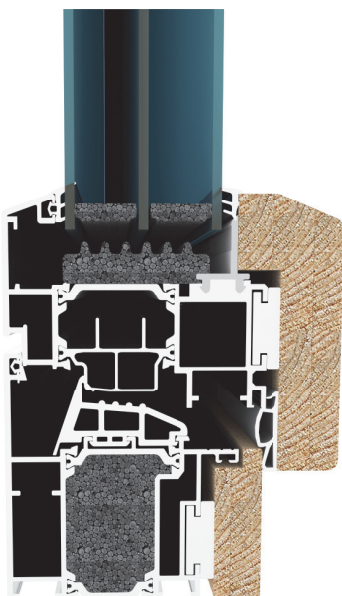

Toplinska provodljivost profila  $U_f$

1,2

Toplinska provodljivost stakla  $U_g$

0,5

Ukupna toplinska provodljivost  $U_w$

0,8

### Photocatalytic Nanoporous Thin Films

Guest Editor:

**Dr. Ivana Grčić**  
University of Zagreb, Zagreb,  
Croatia  
igrčić@gfz.hr

Deadline for manuscript  
submissions:  
**31 January 2021**

#### Message from the Guest Editor

Dear Colleagues,

We are pleased to introduce this Special Issue on "Photocatalytic Nanoporous Thin Films". Recent developments in photocatalytic coatings have pointed toward the paramount importance of further research and a shifting focus on scarcely covered aspects to achieve a desired technology readiness level. This Special Issue will serve as a forum for papers in the following concepts:

Theoretical and experimental research, knowledge, and new conceptual design of photocatalytic nanoporous thin films;

Theoretical and numerical study of optical properties of photocatalytic thin films, including intrinsic phenomena of photon absorption and scattering; computer modeling and simulation to predict coating properties, performance, durability, and reliability in different environments;

Experimental study of water-borne pollutant degradation using photocatalytic thin films focused on either emerging contaminants or state-of-the-art photocatalytic reactors;

Development of complex mathematical models for pollutant degradation over irradiated photocatalytic thin films.



[mdpi.com/sj/51296](https://mdpi.com/sj/51296)

**Special Issue**

### Evaluation of the Crustal Structure

Guest Editor:

**Prof. Dr. Snježana Markušić**  
Department of Geophysics,  
Faculty of Science, University of  
Zagreb, Croatia  
markusic@irb.hr

Deadline for manuscript  
submissions:  
**31 October 2020**

#### Message from the Guest Editor

Determination of the Earth's crustal structure and depth and geometry of the Mohorovičić's discontinuity is a primary task for seismological, geological and geophysical studies, as well as prerequisite for the successful application of many further analyses (e.g., earthquake location, seismic hazard assessment). Over the years seismology and geology have greatly contributed to a better knowledge of the Earth's outer shell structure. Also, examination of crustal geometry, deformation, and evolution, using e.g., seismic studies, field mapping, fracture analysis, petrography, geochemical analysis, allow to discriminate different crustal types and their features, and to define structure heterogeneity (anisotropy and attenuation characterized by coda-Q value and spectral parameter kappa).



[mdpi.com/sj/43776](https://mdpi.com/sj/43776)

**Special Issue**



**SIRRAH projekt d.o.o.**  
Ribarska 4  
31000 Osijek  
Tel: +385 31 250 000

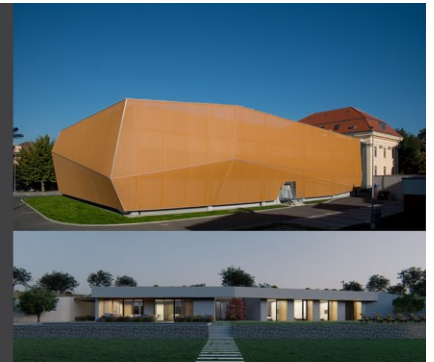

arhitektura  
sport / rekreacija  
industrija  
trgovina  
turizam



Sveučilište u Zagrebu • University of Zagreb  
**STUDENTSKI CENTAR VARAŽDIN**  
 Student Centre Varaždin

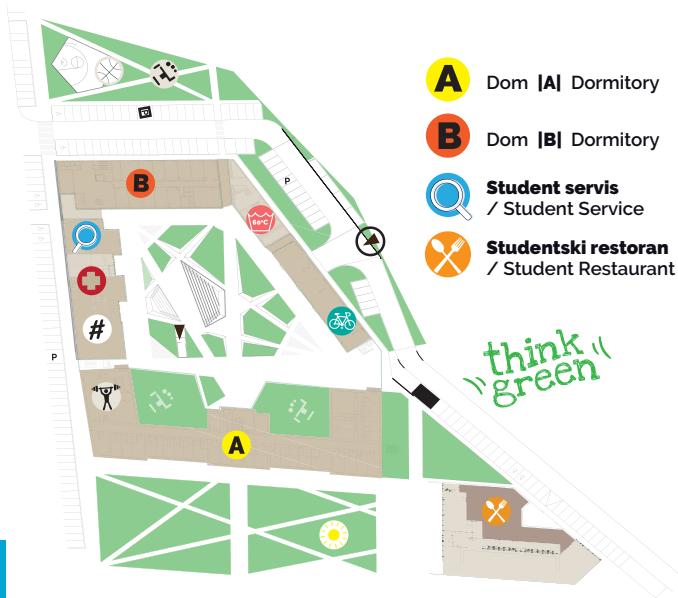

**A** Dom |A| Dormitory

**B** Dom |B| Dormitory

**🔍** Student servis / Student Service

**🍴** Studentski restoran / Student Restaurant

**#** Studentski klub / Student Club

**+** Studentska ambulanta / Student Infirmary

**🏋️** Gym

**🧺** Praonica rublja / Student Laundry Room

**🚲** Spremište za bicikle / Bicycle Storage

**🏈** Sportsko igralište / Sports Playground

**🏃** Fitness park / Fitness Park

**☀️** Solarni park / Solar Park

**▶️** Ulaz u podzemnu garažu / Underground Garage Entrance



[www.scvz.unizg.hr](http://www.scvz.unizg.hr)



[f scvarazdin](https://www.facebook.com/scvarazdin)





## Student Council Faculty of Geotechnical Engineering



- ✓ As the student representatives we promote student interests and take care of the student standard at the Faculty council.
- ✓ We take care on student rights, encourage students to be involved in international mobility, advise students in their needs, etc.

- ✓ We are participating in many projects; form student promotions, study promotions, to scientific and professional project with our professors.
- ✓ We are working on the networking of current students with former students and potential employers.
- ✓ Through various activities our goal is to be the leader of the student standard promotion in Varaždin.



✓ **Every student is important to us.**



CONTACT:

Email: [studentski.zbor@gfv.unizg.hr](mailto:studentski.zbor@gfv.unizg.hr)



Studentski zbor  
Geotehničkog fakulteta



## KRITERIJI ZA UPIS

Lista poretka prijavljenih kandidata za upis sastavlja se prema sljedećem sustavu bodovanja:

- a) Na temelju uspjeha u srednjoj školi = do 500 bodova
- b) Na temelju položenih ispita na državnoj maturi
  - matematika (osnovna razina) = do 500 bodova
- c) Na temelju provjere posebnih sposobnosti = nema bodova
- d) Temeljem dodatnih postignuća učenika = IZRAVAN UPIS (1000 bodova)
  - osvojeno jedno od prva tri mjesta na državnim natjecanjima u RH iz matematike, fizike, kemije, biologije, informatike, astronomije, statistike ili tehničkih znanosti za vrijeme srednjoškolskog obrazovanja.

## AKADEMSKI NAZIVI

Završetkom preddiplomskog studija Inženjerstvo okoliša stječe se 180 ECTS bodova te akademski naziv sveučilišni prvostupnik/prvostupnica inženjer/inženjerka Inženjerstva okoliša (univ.bacc.ing.amb.).

Završetkom diplomskog studija Inženjerstvo okoliša stječe se 120 ECTS bodova te akademski naziv magistar/magistra inženjer/inženjerka Inženjerstva okoliša (mag.ing.amb.).

Završetkom doktorskog studija Inženjerstvo okoliša stječe se 180 ECTS bodova te akademski naziv doktora znanosti (dr.sc.).

## Opis zvanja - kompetencije i osposobljenost

Završetkom sveučilišnoga **preddiplomskog studija** na Geotehničkom fakultetu steći ćeš osnovne kompetencije u identificiranju, definiranju i rješavanju inženjerskih zadataka u Inženjerstvu okoliša.

Od praktičnih znanja kao prvostupnik Inženjerstva okoliša posjedovat ćeš sposobnost korištenja laboratorijske i terenske opreme, promatranja, bilježenja i analize podataka dobivenih laboratorijskim i terenskim ispitivanjima. Znat ćeš izraditi tehničke nacрте ručno i pomoću računala, te pripremiti prezentaciju tehničkih izvješća.

Znanja i kompetencije koja stekneš završetkom sveučilišnoga preddiplomskog studija odgovarajuća su za praćenje diplomskoga sveučilišnog programa na Geotehničkom fakultetu, a omogućavaju ti i praćenje diplomskih studija iz srodnih područja na drugim tehničkim studijima te praćenje različitih programa cjeloživotnog obrazovanja.

**Diplomski studij** Inženjerstvo okoliša traje dvije godine, a uključuje smjerove Geoinženjerstvo okoliša, Upravljanje vodama i Upravljanje okolišem. Ovaj studij mogu upisati studenti koji su završili sveučilišni preddiplomski studij ili strani studij ekvivalentnog programa.

Završetkom diplomskoga studija bit ćeš osposobljen upravljati okolišem na održiv način i preuzeti osobnu i timsku odgovornost za strateško odlučivanje i uspješnu provedbu zadataka pri izradi elaborata, studija i projekata iz inženjerstva okoliša, kao i primijeniti legislativu iz područja zaštite okoliša te preuzeti društvenu i etičku odgovornost za posljedice.

**Doktorski studij** Inženjerstvo okoliša traje tri godine, a njegovim završetkom stječu se kompetencije za provođenje samostalnog istraživačkog rada.

## DODATNE INFORMACIJE



**TAJNIŠTVO:** pon-pet: 07:00 - 15:00  
tel: 042/408-901  
ured.tajnika@gfv.unizg.hr

**REFERADA:** pon-pet: 09:00 - 12:00  
tel: 042/408-904  
studentska.referada@gfv.unizg.hr

Točne datume upisa i ostale relevantne informacije možete potražiti na web stranicama fakulteta:  
[www.gfv.unizg.hr](http://www.gfv.unizg.hr)

**ADRESA:** Geotehnički fakultet Sveučilišta u Zagrebu,  
Hallerova aleja 7, 42000 Varaždin

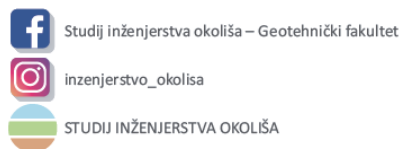

Studij inženjerstva okoliša – Geotehnički fakultet

inzenjerstvo\_okolisa

STUDIJ INŽENJERSTVA OKOLIŠA

## Mogućnost zaposlenja

Znanstvenu karijeru možeš nastaviti razvijati upisom na poslijedoktorski studij Inženjerstvo okoliša na našem Fakultetu. A ako si bio vrlo uspješan student, možda započneš svoju akademsku karijeru kao asistent na našem Fakultetu.

Izvan akademske ili znanstvene sredine, popis mogućih poslodavaca kod kojih se možeš zaposliti doista je raznolik. To su sve institucije državne i lokalne uprave, kao i svi gospodarski subjekti koji zapošljavaju osobe za obavljanje stručnih poslova zaštite okoliša, kao što su na primjer komunalna poduzeća, centri za gospodarenje otpadom, pročišćivači otpadnih voda, eksploatacijska polja. Nadalje, to su i svi oni gospodarski subjekti koji se bave obnovljivim izvorima energije te oni koji svojim proizvodnim procesom mogu naštetiti okolišu.

Ako želiš možeš postati i inspektor za zaštitu okoliša, a s ovim stručnim nazivom ti ni vrata Europske unije neće biti zatvorena.

## Pogodnosti studiranja

Tijekom studiranja na našem Fakultetu kao student Sveučilišta u Zagrebu na raspolaganju imaš razne pogodnosti. Detaljnije o pogodnostima možeš saznati u našem vodiču za brucše:

[http://www.gfv.hr/modules/m\\_gfv/datoteke/vodic\\_za\\_brucose\\_a5\\_final\\_v1.pdf](http://www.gfv.hr/modules/m_gfv/datoteke/vodic_za_brucose_a5_final_v1.pdf)



FAKULTET  
KOJIM ĆEŠ  
MIJENJATI SVIJET  
NA  
BOLJE



## STUDIJ INŽENJERSTVA OKOLIŠA

Geotehnički fakultet Sveučilišta u Zagrebu



## Znanost i suradnja s gospodarstvom

Na Geotehničkom fakultetu provode se i znanstvena istraživanja. Fakultet raspolaže akreditiranim geotehničkim laboratorijem, kao i laboratorijem za inženjerstvo okoliša, laboratorijem za geokemiju okoliša, informatičkim centrom za GIS. Primjereno smo opremljeni i za terenske istraživačke radove. Budući da istraživači koji ih provode sudjeluju i u izvođenju nastave, studentima se prenose najnovije spoznaje i rezultati istraživanja.

Velik doprinos nastavi i znanstvenom radu daje znanstvena i stručna suradnja Geotehničkog fakulteta sa srodnim visokoškolskim institucijama u Republici Hrvatskoj i svijetu. Usporedno s nastavom i znanstveno-istraživačkim radom, Fakultet održava i razvija i suradnju s gospodarstvom kroz izradu mnogobrojnih studija i projekata iz područja Inženjerstva okoliša.



## Sveučilišni doktorski studij Inženjerstva okoliša

odgovor je na zahtjeve naše svakodnevice gdje se susrećemo s problemima onečišćenja okoliša, klimatskim promjenama, potrošnjom resursa kao što su mineralne sirovine, tlo, vode, neadekvatnog upravljanja otpadom i niz drugih okolišnih problema.

<https://www.gfv.unizg.hr/static/doktorski-studij>

Nastavna struktura doktorskog studija koncipirana je u formi pet izbornih modula:

1. Održivo gospodarenje otpadom
2. Okoliš i priroda
3. Geoinženjerstvo okoliša
4. Upravljanje vodama
5. Energetika

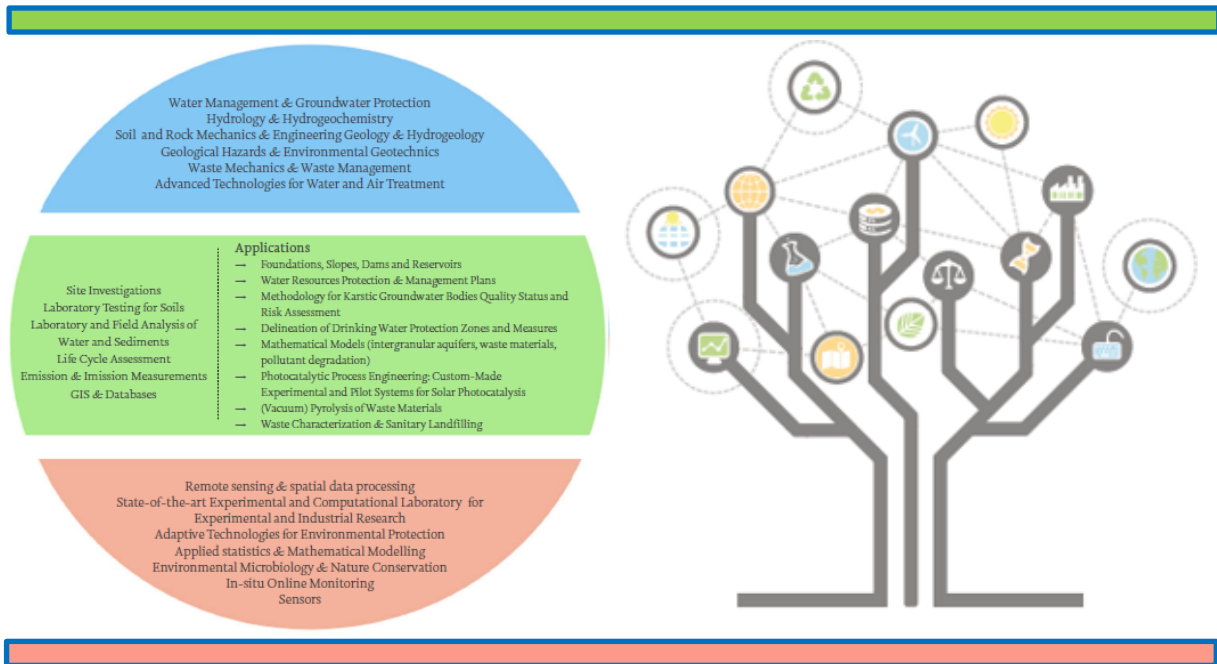

## Postgraduate doctoral study of Environmental Engineering

Problems concerning the field of environmental engineering demand both professional and scientific research approach, which is the only way of finding specific solutions to them. The programme emphasizes current societal needs concerning circular economy, which should enable sustainable waste management, natural resources management and protection, introduction of renewable energy sources and contributes to the mitigation of climate changes.

<https://www.gfv.unizg.hr/static/doktorski-studij>

The curriculum of the doctoral study consists of five modules:

1. Sustainable waste management
2. Environment and nature
3. Environmental Geoen지니어ing
4. Water management
5. Energetics

## PROJEKTI U PROVEDBI / ONGOING PROJECTS



Naziv projekta: **Ispitivanje i modeliranje mehaničkog ponašanja bioosušenog otpada kao preduvjet energetske uporabe – Wte**

Fond: Hrvatska zaklada za znanost

Trajanje projekta: 2018.-2022. Iznos: 920.000,00 kn

Voditelj projekta: *izv.prof. dr.sc. Igor Petrović (GFV)*

Naziv projekta: **Projekt razvoja karijera mladih istraživača – izobrazba novih doktora znanosti**

Fond: Hrvatska zaklada za znanost

Trajanje projekta: 2020. - 2024. Iznos: trošak plaće doktoranda (≈ 527.000,00 kn)

Voditelj projekta: *izv.prof. dr.sc. Igor Petrović (GFV)*



Operativni program  
**KONKURENTNOST  
I KOHEZIJA**

Naziv projekta: **Otpad i sunce u službi fotokatalitičke razgradnje mikroonečišćavala u vodama - OS-MI**

Fond: Europski strukturni i investicijski fondovi; Operativni program "Konkurentnost i kohezija" 2014.-2020. Ulaganje u znanost i inovacije - Prvi poziv, KK.01.1.1.04.0006

Trajanje projekta: 2019.-2022. Iznos: 8.518.482,20 kn

Voditelj projekta: *doc.dr.sc. Ivana Grčić (GFV)*



Naziv projekta: **Upravljanje krškim priobalnim vodonosnicima ugroženima klimatskim promjenama**

Fond: Europski strukturni i investicijski fondovi; Operativni program "Konkurentnost i kohezija" 2014.-2020.; Shema za jačanje primijenjenih istraživanja za mjere prilagodbe klimatskim promjenama

Trajanje projekta: 2020. - 2022. Iznos: 3.018.114,67 kn

Voditelj projekta: *prof.dr.sc. Ranko Biondić (GFV)*



STJECANJE KLJUČNIH PRAKTIČNIH VJEŠTINA  
U PODRUČJU INŽENJERSTVA OKOLIŠA

Uslužni Centar za Inženjerske Poslove u Zagrebu (ZIPP) Partneri: Institut za razvoj i međunarodne odnose (IRMO), Hrvatsko društvo za razvoj geotehnike (HRDG), Virovitičko-šibikanska sveučilišna zajednica (VSSJ), Društvo inženjera strojarstva (DIS), Društvo inženjera građevinarstva (DIG), Društvo inženjera elektrotehnike (DIE), Društvo inženjera prometne tehnologije (DIP), Društvo inženjera zaštitne tehnologije (DIZT), Društvo inženjera zaštitne tehnologije (DIZT), Društvo inženjera zaštitne tehnologije (DIZT)



Projekt je sufinancirala Europska unija iz Europskog socijalnog fonda.

Naziv projekta: **Stjecanje ključnih praktičnih vještina u području inženjerstva okoliša**

Fond: Europski socijalni fond 2014.-2020.

Trajanje projekta: 2020. - 2023. Iznos: 3.974.834,79 kn

Nositelj projekta: *Geotehnički fakultet*

Naziv projekta: **VIRTULAB-integrirani laboratorij  
za primarne i sekundarne sirovine**

Fond: Europski strukturalni i investicijski fondovi; Operativni program "Konkurentnost i kohezija" 2014.-2020.

Trajanje projekta: 2018. - 2020. Iznos: 14.186.222,23 kn

*Geotehnički fakultet je partner na projektu*



**PLITVIČKA  
JEZERA** Nacionalni park  
National Park

Naziv projekta: **Hidrodinamičko modeliranje  
sustava Plitvičkih jezera**

Fond: Javna ustanova „Nacionalni park Plitvička jezera“

Trajanje projekta: 2016. - 2020. Iznos: 2.656.000,00 kn

*Geotehnički fakultet je partner na projektu*

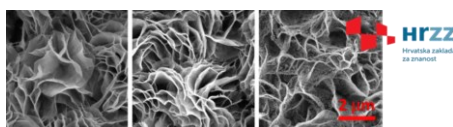

Naziv projekta: **Nanokompoziti s perovskitima za fotovoltaike, fotokatalizu i  
senzoriku - NanoPeroPhotoSens**

Fond: Hrvatska zaklada za znanost

Trajanje projekta: 2018. - 2022. Iznos: 1.480.535,00 kn

*Geotehnički fakultet je partner na projektu*



Djelatnici Geotehničkog fakulteta trenutno su aktivni na 4 projekta koje provodi The European Cooperation in Science and Technology (COST Association).

Trajanje projekata: **2017 – 2021**

**COST Action CA16215:** European network for the promotion of portable, affordable and simple analytical platforms

**COST Action CA16101:** MULTI-modal Imaging of FOREnsic SciEnce Evidence

Trajanje projekata: **2018 – 2022**

**COST Action CA17136:** Indoor Air Pollution Network

**COST Action CA17131:** The Soil Science & Archaeo-Geophysics Alliance: going beyond prospection

# PREVIOUS ISSUES

<https://www.gfv.unizg.hr/static/online-library-open-access>



## INSTRUCTIONS FOR AUTHORS

The journal „ENVIRONMENTAL ENGINEERING-INŽENJERSTVO OKOLIŠA“ publishes scientific and technical papers and other articles in the interdisciplinary area of environmental engineering. The scientific topics covered by the Journal include geo-engineering, water resources management, technical aspects of environmental protection and similar areas. The journal publishes papers in English. Papers are accepted for publication after they have received a positive review and are categorized as an original scientific paper, preliminary communications, review paper or technical paper.

The journal is published biannually. There are no charges for printing the paper. As a rule, the length of the paper is not limited. However, it is recommended that it should not be longer than 15 single-spaced A4 pages, all figures included.

Figures are printed in greyscale, and authors should take it into account when preparing their manuscript. However, authors may, in agreement with the editorial board, prepare figures in colour when they deem it necessary for the understanding of what the figure shows. The figures in colour approved by the editorial board will not be additionally charged.

When a paper is submitted for review, this implies that the paper has not been previously published or that it is not being reviewed by another journal. The author is responsible for the content of the paper and for obtaining consent, where applicable, to publish particular data.

The first page should contain the title of the paper, the authors' names, the institution of employment, the authors' email addresses, the abstract and keywords. It is recommended that the title of the paper should be illustrative and clearly reflect the content of the paper. If the title contains local names, then a generally recognizable name in a wider region should be included. The abstract should not exceed 300 words, and there should be 4 to 6 keywords. If none of the authors has been specified as lead author, the editors will exclusively contact the first mentioned author.

Authors should submit their paper by e-mail to: [casopis@gfv.unizg.hr](mailto:casopis@gfv.unizg.hr). The paper should be prepared in Microsoft Word in A4 page format, with 25 mm margins and 1.5 line spacing, in one column aligned to both sides. The text should be written in 10 pt Times New Roman, and the pages should have automatic numbering in the bottom right corner. Depending on the content, the text should be divided into several sections whose headings are in 11 pt bold and aligned to the left. The paper should be written in the third person singular and has to be terminologically harmonized with legal regulations in force and the international system of units (SI). All equations have to be numbered; tables and figures should also be numbered with a heading and inserted in the appropriate place in the article. **For citation of equations, figures and table in text use bold font.** All figures (images, diagrams, photographs) have to be prepared for graphic reproduction at a minimum resolution of 300 dpi and submitted in a separate map.

When **citing papers in the text** with **blue colour**, only previously published papers should be mentioned. If authors consider it necessary, personal communication and unpublished papers may be cited in the paper, but in an appropriate manner, either as part of the text or in acknowledgements at the end of the paper. **References** include an alphabetical list of published papers that have been cited in the text. The **Harvard citation** and referencing style should be used.

If the paper is accepted for publication, the authors are obliged to harmonize the paper with the instructions given by the reviewers/editors. If the authors do not accept the reviewers'/editors' remarks or if they do not submit the corrected version of the paper within three months, the editorial board will deem that the authors have withdrawn their paper from the procedure and no longer wish to have it published.

Prior to its publication, the authors will receive the paper for inspection and final revision.

The paper which has been through all the phases of text preparation will first be published online, and then in the printed edition. Authors will receive a separate in pdf format as well as one copy of the journal in which the paper was published.